

INTERNATIONAL Scientific JOURNAL  
ISSN: 2579-2822

# AGRISCIENCE AND TECHNOLOGY

ARMENIAN NATIONAL AGRARIAN UNIVERSITY



ԱԳՐՈՒԳԻՏՈՒԹՅՈՒՆ ԵՎ ՏԵԽՆՈԼՈԳԻԱ

ՀԱՅԱՍՏԱՆԻ ԱԶԳԱՅԻՆ ԱԳՐԱՐԱՅԻՆ ՀԱՄԱԼՍԱՐԱՆ

АГРОНАУКА И ТЕХНОЛОГИЯ

НАЦИОНАЛЬНЫЙ АГРАРНЫЙ УНИВЕРСИТЕТ АРМЕНИИ



**4/84**  
**2023**



## ԽՄԲԱԳՐԱԿԱՆ ԽՈՐՀՈՒՐԴ

Նախագահ	Վ.Է. Ուռուտյան
Գլխավոր խմբագիր	Հ.Ս. Ծպնեցյան
Խորհրդի կազմ	Մ.Ս. Ազադ (Հնդկաստան), Ֆ. Արիոն (Ռումինիա), Ե.Վ. Բելովա (Ռուսաստան), Ի. Բոբոջոնով (Գերմանիա), Ա. Դյակոն (Լեհաստան), Ի. Դյուրիչ (Գերմանիա), Գ. Կուտելիա (Վրաստան), Ջ. Յանֆ (Գերմանիա), Վ. Հեբոյան (ԱՄՆ), Վ. Հովհաննիսյան (ԱՄՆ), Կ.Լ. Մանուելյան Ֆուստե (Իտալիա), Ն. Մերենդինո (Իտալիա), Ս. Մինտա (Լեհաստան), Վ.Ի. Նեչաև (Ռուսաստան), Ա. Շանոյան (ԱՄՆ), Պ. Պիտտիա (Իտալիա), Ա.Ռ. Սագուես (Իսպանիա), Յ.Վ. Վերտակովա (Ռուսաստան), Ա.Ֆ. Քուտելիա (Իսպանիա) Ա.Յ. Աբովյան, Ս.Ս. Ավետիսյան, Գ.Յ. Գասպարյան, Ս.Յ. Դավթյան, Գ.Ս. Եղիազարյան, Ա.Ս. Եսոյան, Հ.Ս. Զաքարյան, Ա.Վ. Խոջոյան, Գ.Ռ. Համբարձումյան, Է.Ս. Դազարյան, Ս.Վ. Մելոյան, Տ.Ժ. Չիտչյան, Դ.Ա. Պիպոյան, Գ.Ժ. Սարգսյան, Ա.Ռ. Սիմոնյան, Ա.Զ. Տեր-Գրիգորյան, Պ.Ա. Տոնապետյան, Ա.Զ. Փեփոյան
Պատասխանատու խմբագիր	Գ.Վ. Մնացականյան
Խմբագիր-սրբագրիչներ	Ս.Ա. Եղիազարյան, Մ.Ժ. Դազարյան, Ս.Ռ. Պետրոսյան, Ա.Շ. Սուքիասյան, Բ.Վ. Վահրամյանս Խոսրովիզադ
Համակարգչային ձևավորում	Կ.Ս. Վարդանյան
Վարչական օգնական	Ս.Ս. Ասատրյան

## РЕДАКЦИОННАЯ КОЛЛЕГИЯ

Председатель	В.Э. Урутян
Главный редактор	Г.С. Цпнецян
Состав редколлегии	М.С. Азад (Индия), Ф. Арион (Румыния), Е.В. Белова (Россия), И. Бободжонов (Германия), Ю.В. Вертакова (Россия), Дж. Ханф (Германия), А. Диакон (Польша), И. Дюрич (Германия), Г. Кутелиа (Грузия), А.Ф. Куэсада (Испания), Н. Мерендино (Италия), С. Минта (Польша), В.И. Неचाев (Россия), В. Ованнисян (США), П. Питтия (Италия), А.Р. Сагуэс (Испания), К.Л. Мануелян Фусте (Италия), В. Хебойан (США), А. Шаноян (США) А.Ю. Абовян, С.С. Аветисян, Г.Р. Амбарцумян, Г.А. Гаспарян, С.А. Давеян, Г.М. Егиазарян, А.М. Есоян, Г.С. Закоян, Э.С. Казарян, С.В. Мелоян, А.З. Пепоян, Д.А. Пипоян, Г.Ж. Саркисян, А.Р. Симонян, А.Дж. Тер-Григорян, П.А. Тонапетян, А.К. Ходжоян, Т.Ж. Читчян
Ответственный редактор	Г.В. Мнацаканян
Редакторы-корректоры	Б.В. Ваграмянс-Хосровизад, С.А. Егиазарян, М.Ж. Казарян, С.Р. Петросян, А.Ш. Сукиасян
Компьютерный дизайн	К.С. Варданын
Административный ассистент	С.С. Асатрян

## EDITORIAL BOARD

Chairman	V.E. Urutyun
Editor-In-Chief	H.S. Tspnetyan
Editorial Committee	F. Arion (Romania), M.S. Azad (India), Ye.V. Belova (Russia), I. Bobojonov (Germany), I. Djurić (Germany), A. Dyjakon (Poland), J. Hanf (Germany), V. Heboyan (USA), V. Hovhannisyun (USA), G. Kutelia (Georgia), C.L. Manuelian Fusté (Italy), N. Merendino (Italy), S. Minta (Poland), V.I. Nechaev (Russia), P. Pittia (Italy), A.F. Quesada (Spain), A.X. Roig Sagués (Spain), A. Shanoyan (USA), Yu. Vertakova (Russia) A.Yu. Abovyan, S.S. Avetisyan, T.Zh. Chitchyan, S.H. Daveyan, G.H. Gasparyan, E.S. Ghazaryan, G.R. Hambardzumyan, A.K. Khojoyan, S.V. Meloyan, A.Z. Pepoyan, D.A. Pipoyan, G.Zh. Sargsyan, A.R. Simonyan, A.J. Ter-Grigoryan, P.A. Tonapetyan, G.M. Yeghiazaryan, A.M. Yesoyan, H.S. Zaqoyan
Associate Editor	G.V. Mnatsakanyan
Editor-Proofreaders	M.Zh. Ghazaryan, S.R. Petrosyan, A.Sh. Sukiasyan, B.V. Vahramians Khosravizad, S.A. Yeghiazaryan
Computer Design	K.S. Vardanyan
Administrative Assistant	S.S. Asatryan

☎ (+374 12) 56-07-12, (+374 10) 58-19-12

✉ [journal@anau.am](mailto:journal@anau.am)

URL: <https://anau.am>

Հասցե՝ Երևան 0009, Տերյան 74

Адрес: Ереван 0009, Терян 74

Address: 74 Teryan, Yerevan 0009

International Scientific Journal

ISSN: 2579 - 2822

# AGRISCIENCE AND TECHNOLOGY

Armenian National Agrarian University

**ԱԳՐՈՎԻՏՈՒԹՅՈՒՆ ԵՎ ՏԵԽՆՈԼՈԳԻԱ**

Հայաստանի ազգային ագրարային համալսարան

**АГРОНАУКА И ТЕХНОЛОГИЯ**

Национальный аграрный университет Армении

**4/84 2023**

Երևան Yerevan Երևան  
2023

# CONTENTS

## Agricultural Engineering

- A.M. Yesoyan,  
G.M. Mikayelyan,  
G.A. Karapetyan
- Development of the Technological Scheme of the Combined Frontal Plough and the Justification of the Parameters of Disc Working Bodies 315

## Agricultural Economics and Agribusiness

- P.S. Efendyan,  
M.Sh. Mkrtchyan,  
N.A. Khudaverdyan
- Analysis of the Current Procedures for Cadastral Assessment of Agricultural Lands in Armenia 321

## Agronomy and Agroecology

- L.H. Atchemyan,  
V.S. Mirzoyan,  
N.K. Petrosyan,  
G.A. Karapetyan
- Studying Stimulant and Fungicidal Properties of Preparation “Argitos Agro” against Powdery Mildew in Greenhouse Conditions 327
- G.H. Gasparyan,  
S.K. Yeritsyan,  
L.S. Yeritsyan,  
G.S. Santrosyan
- The Effect of Applying Mineral Fertilizers Through Drip Irrigation and Furrow Method on the Movement of Mobile Nutrients in the Soil and the Growth, Development, and Accumulation of Nutrients in the Walnut Leaves 332
- K.A. Gharakhanyan,  
M.H. Galstyan
- The Effect of Various Tillage Methods and Meliorants Application against their Background on the Dynamics of Macronutrients Accumulation in the Winter Wheat Plants and their Output via Crop Yield 340
- AM. Tadevosyan,  
N.A. Gasparyan,  
H.Z. Terteryan
- Study of Growth, Yield, and Yield Quality Indicators of Tomato Hybrids in Hydroponic Systems under Greenhouse Conditions 347

## Veterinary Science and Animal Breeding

- H.M. Danelyan,  
P.G. Tumanyan,  
A.A. Hovhannisyan,  
Kh.V. Sargsyan
- Knowledge, Attitudes, Practices (KAP) of Brucellosis in Occupationally Exposed Groups in Armenia 353

N.A. Harutyunyan, Zh.T. Chitchyan, M.V. Badalyan, A.Z. Pepoyan	Heat Stress and Cultivable Intestinal Bacteria of Lehmann Brown Hens	359
M.A. Sargsyan	Epidemiological Analysis of the Swine Perfringens Disease in the Aragatsotn Region	366

### Food Science and Technology

A.H. Gabrielyan, G.B. Iskandaryan	The Investigation of the Untapped Winemaking Potential of the Grape Variety “Hastakot”	372
A.S. Hovhannisyan, M.R. Beglaryan, D.A. Pipoyan, N. Merendino	Cow Milk Total Protein Analysis and Daily Intake Estimation in Armenia	377
N.G. Hovhannisyan, H.V. Mkhitaryan, G.B. Aperyanyan, R.S. Hayrapetyan	Using Alternative Raw Materials in Sugar Confectionery Production	383
T.L. Khachatryan, L.V. Shahinyan, Sh.H. Harutyunyan, A.H. Nersisyan	Studying the Effects of Various Yeast on the Three-Year Aging Process of Brandy Spirits Made From “Kangun” and “Meghrabuyr” Grape Varieties	389



Journal homepage: [anau.am/scientific-journal](http://anau.am/scientific-journal)

doi: [10.52276/25792822-2023.4-315](https://doi.org/10.52276/25792822-2023.4-315)

UDC 631.316.022

## Development of the Technological Scheme of the Combined Frontal Plough and the Justification of the Parameters of Disc Working Bodies

A.M. Yesoyan, G.M. Mikayelyan, G.A. Karapetyan

Armenian National Agrarian University

[esoyan.62@mail.ru](mailto:esoyan.62@mail.ru), [gegam.mikayelyan@bk.ru](mailto:gegam.mikayelyan@bk.ru), [kgevorg1998@gmail.com](mailto:kgevorg1998@gmail.com)

### ARTICLE INFO

#### Keywords:

*combined plough,  
mechanical engineering,  
minimum tillage,  
soil,  
soil erosion,  
plowing*

### ABSTRACT

It has been established that there is a need for regular inclusion of soil plowing in the process of minimum tillage. The need for regular inclusion of soil plowing in the process of minimum tillage has been established. A technological scheme for a combined machine has been developed, and a combined front plough for smooth plowing capable of performing both basic and surface soil tillage in a single pass has been proposed. Several geometric, operational, and technological parameters of the proposed plow working body have been determined. The feasibility of using a combined front plough for smooth plowing has been confirmed.

### Introduction

Agricultural machines and tools produced in the territory of the former USSR, which still occupy a significant share in the machinery park of Armenia, are of low quality. Their reliability and durability are inferior to their global counterparts (Tsench, et al., 2018).

The creation of high-quality agricultural machinery will become a reality if it is based on modern methods developed in various countries around the world, accurate calculations, thorough research, and advanced cutting-edge technologies. Moreover, it is essential to maintain a high level of operational reliability of agricultural machines in the future, based on the latest methods of

technical maintenance and repair and a base of technical means (Zimin and Smetnev, 2015).

### Materials and methods

At the current stage of agricultural production, minimum tillage is being emphasized, as it ensures the reduction of operational costs and soil erosion by combining the necessary technological processes of soil cultivation (Belousov and Trubilin, 2017).

In recent years, there have been frequent attempts to eliminate the plowing process in the context of applying new technologies (Kulikova and Zagudaeva, 2019).

However, the results of numerous studies have confirmed that completely removing plowing from technological processes is a categorical mistake. This is because it results in the lower layers of the soil / deeper than 15cm / not being cultivated at all, with only the top layer of soil being utilized. Although plowing is a very heavy and energy-intensive process, like many researchers, we also support the idea that plowing should be carried out periodically, once every 3-4 years. This approach allows the lower layers of the soil to participate in cultivation while helping to restore the fertility of the surface layers (Varin and Iskhakov, 2023). In all cases, one of the requirements of new technology is to reduce the number of passes of technical means in the field, which must be performed imperatively (Alekseeva, et al., 2014). Therefore, in the case of including the plowing technological process, the number of passes should be reduced, and minimum tillage should be ensured. This means that plowing should be combined with the following technological process, namely, performing both the primary and surface soil cultivation in one pass of the aggregate. The solution to this problem is to create a combined agricultural machine that simultaneously performs plowing to a depth of 25-30 cm and surface cultivation to a depth of 15-20 cm. For this approach to solving the problem, we have chosen the plow + disc harrow combination.

The main disadvantage of such combined machines is their high traction resistance. To reduce this, modifications have been made to the structure of the harrow and the plow, as well as optimization of the technological parameters of the working organs (Tonapetyan, et al., 2021).

Creating a machine combined with traditional plows involves a series of complexities. The issue is that the moldboard of traditional plough has a sequential arrangement, leading to their considerable length, which will increase even further when combined. As a result, we will end up with a very long aggregate, which becomes impractical in the soils of Armenia. This is due to the small sizes of the plots, the frequency of turns and maneuvers, the fragmented nature of the fields, the inconvenience of moving the aggregate from one field to another, and other factors (Mirzakhodjaev, et al., 2018).

## Results and discussions

Considering the above-mentioned factors for designing a combined plow, we have decided to focus on the design of a front plough, which has an advantage over traditional plows in that its tines are arranged broadly, which in turn gives both the plow and the aggregate compact dimensions.

In addition, the tines and other working organs have a symmetrical arrangement, which is important for the course stability and technological consistency of the aggregate. The main disadvantage observed in the front plough is its high traction resistance, which comes from the fact that these plows, in addition to their main moldboards, also have auxiliary working organs like turner plows, which assist in turning the soil in their furrow.

The main moldboards of the front plow have a curved surface, which, as is well known, turns the soil well but does not crumble it effectively. With this type of plow, the furrows often turn out very rough, especially in soils with lots of weeds and particularly in harder soils. The turning of the furrow by two working organs often causes disruptions, which further increases the traction resistance and, in some cases, can even halt the process. To make it combined, the auxiliary working organs were initially removed, resulting in the furrows not being completely turned into their furrow. Since the two adjacent moldboards work in opposition, the incompletely turned furrows in the central part of the tines create a ridge-shaped soil heap, as shown in Figure 1a.

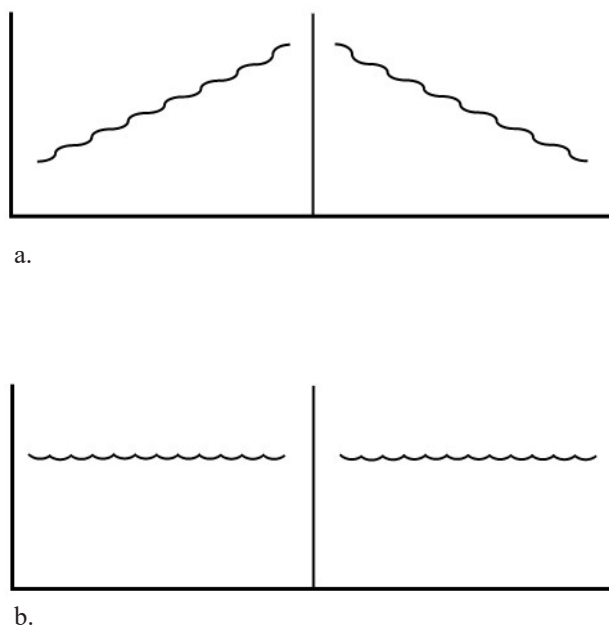

**Figure 1.** Appearance of the Furrows. *a. After the passage of the moldboards of the combined plow, b. After the passage of the disc coulters of the combined plow (composed by the authors).*

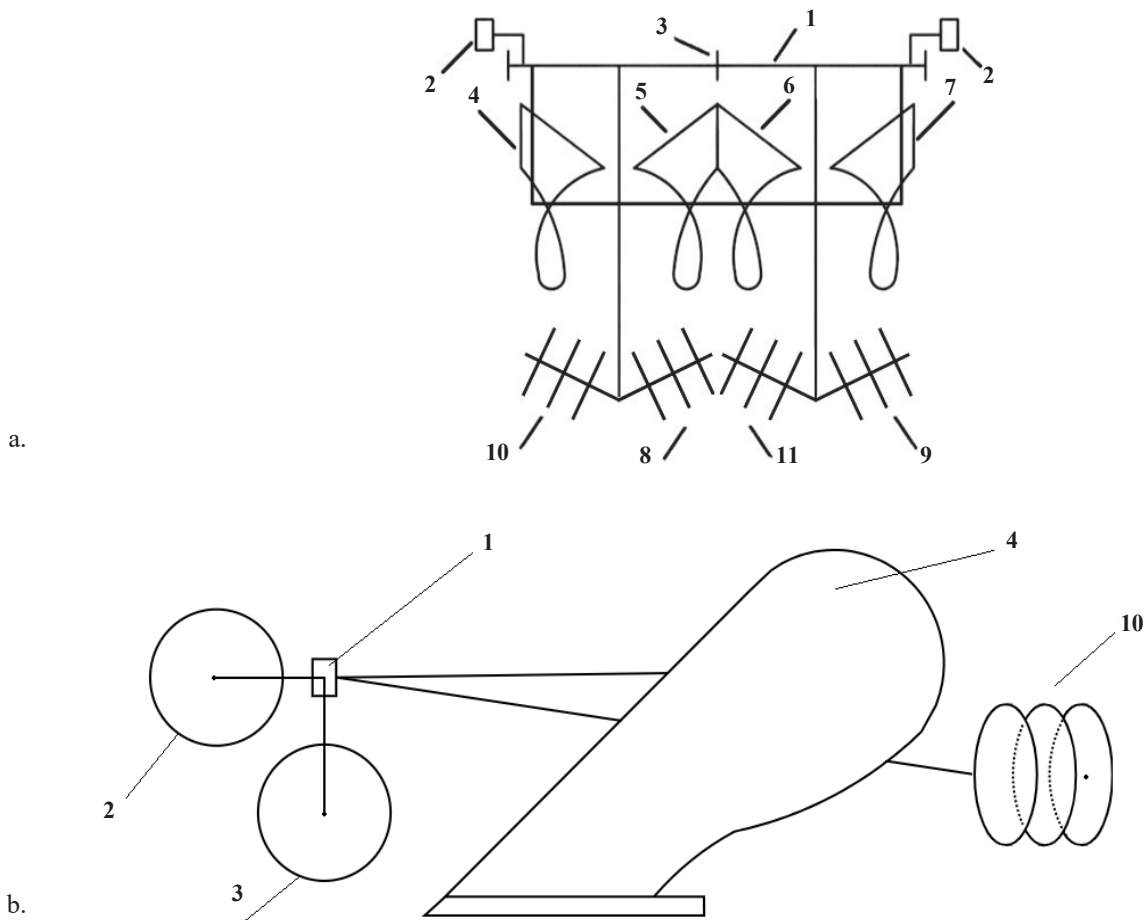

**Figure 2.** Front plough for combined smooth plowing:

a. Horizontal Projection,

b. Profile Projection: 1. Frame, 2. Supporting Wheels, 3. Blades, Right-turning 4. Left-turning and 6 Left-turning 5. Moldboards, 6. Left-turning, 7 moldboards, Right-turning 8. Left-turning, 9. Left-turning, 10. Disc Coulters, 11. Disc Coulters (composed by the authors).

To spread and simultaneously crumble the soil, combat weeds, and achieve a smooth, crumbled surface, disc coulters are placed following the moldboards in the combined plow (Figure 2) (Yesoyan , et al., 2023).

From a technological and energy perspective, the removal of the turner plow from the design of the front plough and the inclusion of disc coulters is justified. Additionally, the proposed machine achieves a seedbed-ready surface in a single pass, making its use justified from a practical standpoint (see Figure 1b). This proposed machine has been granted a patent in Armenia (RA Patent No. 846Y, (2023)).

The parameters of the moldboards with a curved surface in the front plough have not changed, so the basis for the parameters of the working organs of the combined machine has been the disc coulters only.

The front plough for combined smooth plowing has four-disc coulters, each located across the width of one tine.

The parameters we have focused on for the disc coulters are:

- the inclusion width -  $B_{coulters}$
- the working depth -  $h$
- the number of discs in the coulters -  $n$  and the distance -  $d$
- the angle of attack of the disc -  $\alpha$
- the radius of curvature of the disc -  $R$
- the diameter of the disc -  $D$ .

Each coulters "services" one tine, so the width of inclusion of one coulters should equal the width of inclusion of one tine of the front plough, which is 45 cm.



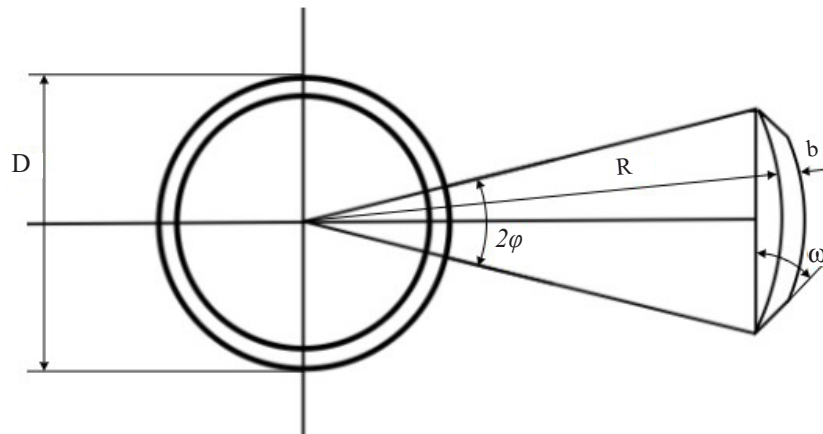

**Figure 3.** Spherical disc 1. There is a relationship between the central angle  $2\varphi$ , the diameter of the disc  $D$ , and the radius of curvature  $R$  of the disc (Panov A.I., Puzikov S.S., 2018).

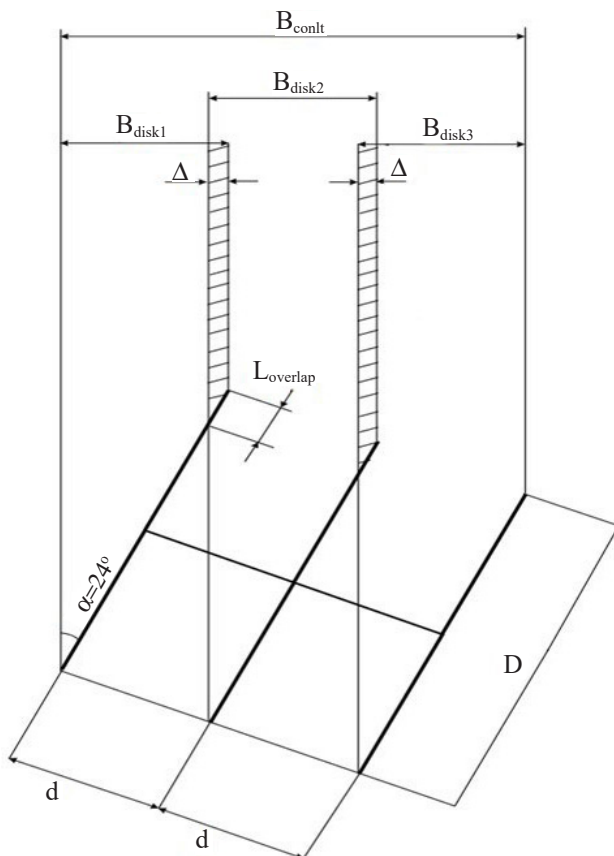

**Figure 4.** Schematic for Determining the Inclusion Width of the Disc and Coulter. (composed by the authors).

Here, the problem boils down to determining the inclusion width of one disc of the coulter, based on which the number of discs in the coulter will be determined. To determine the width of inclusion of the disc, it is first necessary to determine the diameter of the disc and the angle of attack.

We are choosing a spherical disc (see Figure 3).

$$D = 2R \sin \varphi \tag{1}$$

The discs are standardized and the most commonly used diameters are 450, 510, and 600 mm (GOST 198-75). Considering that after the passage of the moldboards of the front plough, a ridge-shaped surface is formed, which needs to be smoothed by the selected discs, we choose the largest available diameter for the discs,  $D = 600$  mm, which according to GOST, has a thickness of  $b = 4.0$  mm.

The aforementioned GOST also standardizes certain geometric parameters of the disc, specifically the angle  $\varphi$ . For the selected disc diameter,  $\varphi$  is set at  $25^\circ$ . Consequently, the radius of curvature of the disc will be calculated as  $R = D / (2 \sin \varphi) = 710$  mm.

The angle of attack of the disc depends on the depth of cultivation. According to GOST, for cultivation depths of 10 to 20 cm, the angle of attack of the disc is set between 6 and 24 degrees (GOST 10267-69).

Considering that in this case the discs are required to process a ridge-shaped surface, we choose the largest prescribed depth,  $h = h_{max} = 20$  cm, which corresponds to the maximum angle of attack  $\alpha = 24^\circ$  (Figure 4).

Therefore, the inclusion width of 1 disc will be:

$$B_{disc} D \sin \alpha = 0.6 * \sin 24 = 24 \text{ cm.} \quad (2)$$

The inclusion width of the disc coulter will be determined by the following formula.

$$B_{coulter} = n B_{disc} - (n-1) \Delta = n D \sin \alpha - (n-1) \Delta, \quad (3)$$

where.  $n$  is the number of discs in the coulter,  $\Delta$  and is the overlap measurement between consecutive discs.

The inclusion width of a single disc coulter should be equal to the width of the inclusion of one moldboard, which is 0.45 m. Therefore, from equation (3), we get the result.

$$n D \sin \alpha - (n-1) \Delta = 0.45. \quad (4)$$

Assuming the overlap size to be  $\Delta = 12$  cm (to avoid untreated areas during turns), the number of discs in one coulter will be  $n = 2.75$ . We round this to  $n = 3$  discs. Using Figure 4, we can determine the distance between the discs in the coulter.

$$\begin{aligned} d &= (D - L_{\text{overlap}}) \cot \alpha = (D - \Delta / \sin \alpha) \cot \alpha = \\ &= (0.6 - 0.12 / \sin 24) \cot 24 = 0.67 \text{ m.} \end{aligned} \quad (5)$$

## Conclusion

1. Minimum tillage technologies do not typically include plowing. However, considering the serious negative consequences of omitting it, it is proposed to include plowing in the pre-sowing cultivation process at certain intervals, specifically once every 3-4 years. One of the ways to achieve this is through the creation of a combined machine based on plow bases.

2. The construction of the combined plow is structurally suitable for execution on the bases of front ploughs, which have compact dimensions and symmetrical and broad arrangement of moldboards.

3. On the base of the PFN-2A front plough, has been proposed combined plough for smooth plowing. Its turner plows have been removed from the structure, and disc coulters have been added with the following parameters:

- Number of coulters: 4,
- Type of disc: Spherical,
- Width of inclusion of one coulter: 45 cm,
- Diameter of the disc: 600 mm,
- Angle of attack of the disc:  $24^\circ$ ,

- Number of discs in the coulter: 3,
- Radius of curvature of the disc: 710 mm,
- Distance between discs in the coulter: 67 cm.

4. The use of the combined front plough is justified from technological, energetic, and practical perspectives.

## References

1. Alekseeva, A.I., Nesterov, E.S., Shardina, G.E. (2014). Analysis of Combined Soil Cultivating Machines and Trends in Their Development. In the collection: Problems of Economical Operation and Exploitation of Auto-Tractor Machinery. Proceedings of the International Scientific and Technical Seminar named after V.V. Mikhailov. - pp. 7-9 (in Russian)
2. Belousov, S.V., Trubilin, E.I. (2017). Methods and Directions of Primary Soil tillage. In the collection: "Scientific Support of the Agro-Industrial Complex. Proceedings based on the materials of the X All-Russian Conference of Young Scientists, dedicated to the 120th anniversary of I.S. Kosenko. Responsible editor A.G. Koschaev. - pp. 478-479 (in Russian).
3. GOST 198-75. Details of agricultural machinery. Discs <https://www.russiangost.com/p-236268-gost-198-75.aspx>.
4. GOST 10267-69. Disk harrows <https://www.russiangost.com/p-222644-gost-10267-69.aspx>.
5. Kulikova, E.G. (2019). Minimum Soil tillage in Restoring Soil Fertility. In the book: Ecology and Reclamation of Agrolandscapes: Prospects and Achievements of Young Scientists. Proceedings of the VII International Scientific and Practical Conference of Young Scientists, dedicated to the 120th birthday of Anatoly Vasilievich Alben, - pp. 274-275 (in Russian).
6. Mirzakhodjaev, Sh.Sh., Toshkulov, F.T., Beknazarov, A.Zh. (2018). Combined Frontal Plow with Passive and Active Working Bodies. In the collection: Current State, Traditions, and Innovative Technologies in the Development of the Agro-Industrial Complex. Proceedings of the International Scientific and Practical Conference within the framework of the XXVIII International Specialized Exhibition Agrocomplex-2018. Bashkir State Agrarian University, - pp. 99-102 (in Russian).
7. Panov, A.I., Puzikov, S.S. (2018). Calculation of Parameters of the Combined Plow Body. In the collection: Agro-Industrial Complex: Contours of the

- Future. Proceedings of the IX International Scientific and Practical Conference of Students, Postgraduates, and Young Scientists, - pp. 272-275 <http://dx.doi.org/10.52070/978-5-00120-267-7> 2021 (in Russian).
8. Tonapetyan, P., Gasparyan, P., Yesoyan, A. (2021). Peculiarities and Selection of Technology of Minimum Soil Tillage According to Zoning. News of High Technologies, No. 2 (16), - pp. 30-36 (in Russian).
9. Tsench, Y.S., Maslov, G.G., Trubilin, E.G. (2018). To the History of Agricultural Machinery Development, Vestnik of Bashkir State Agrarian University. No. 3 (47), - pp. 117-123 (in Russian).
10. Varin, D.Yu., Iskhakov, I.A. (2023). Tillage Technologies to increase Soil Fertility. In the collection: Development of the Agro-Industrial Complex and Rural Areas in the Context of Economic Modernization. Proceedings of the IV International Scientific and Practical Conference, dedicated to the memory of Doctor of Economic Sciences, Professor N.S. Katkov. Kazan, - pp. 30-35 (in Russian).
11. Yesoyan, A.M., Mkrtchyan, H.D., Mikayelyan, G.M., Karapetyan, G.A. (2023). RA Patent, No. 846Y (in Armenian).
12. Zagudaeva, Y.S. (2019). Minimum and Zero Soil Tillage, Academy of Pedagogical Ideas Novation. Series: Student Scientific Vestnik. No. 1, - pp. 275-278 (in Russian).
13. Zimin, V.K., Smetnev, A.S. (2015). Modern Trends in Technical Service of Agricultural Machinery, Vestnik of the Russian State Distance Learning Agricultural University. No. 19 (24), - pp. 69-73 (in Russian).

---

*Accepted on 10.11.2023*

*Reviewed on 21.11.2023*



Journal homepage: [anau.am/scientific-journal](http://anau.am/scientific-journal)

doi: [10.52276/25792822-2023.4-321](https://doi.org/10.52276/25792822-2023.4-321)

UDC 528.443(479.25)

## Analysis of the Current Procedures for Cadastral Assessment of Agricultural Lands in Armenia

P.S. Efendyan, M.Sh. Mkrтчyan, N.A. Khudaverdyan

Armenian National Agrarian University

[armgeoinform@mail.ru](mailto:armgeoinform@mail.ru), [mkrтч-mkrтчyan@mail.ru](mailto:mkrтч-mkrтчyan@mail.ru), [naneharmeni@gmail.com](mailto:naneharmeni@gmail.com)

### ARTICLE INFO

#### **Keywords:**

*cadastral assessment,  
land cadaster,  
agricultural lands,  
land management,  
land-cadastral zoning*

### ABSTRACT

In 2021, the procedure for cadastral assessment approximated to market value of real estate for real estate taxation (adopted in 2019) came into force in the Republic of Armenia, whereby a new methodology for cadastral assessment of other land fund categories of the RA was determined. The procedure does not apply to agricultural lands, which to this day are assessed and taxed according to the methodology and values that were determined in 1997. In this article, we have addressed some points of the current methodology, which, in our opinion, require revision or additional argumentation.

### Introduction

In 2021, the procedure for cadastral assessment approximated to market value of real estate for real estate taxation (adopted in 2019) came into force in the Republic of Armenia, whereby a new methodology for cadastral assessment of other land fund categories of the RA was determined. (The Law of the RA (HO-225-N), 2019). Whereas the cadastral values and the net incomes for agricultural lands were determined by the Decision of the Government of the Republic of Armenia No. 237 of July 3, 1997 “On approval of the data of the state land cadaster of agricultural lands and unused lands of the Republic of Armenia”.

All subsequent decisions that determined the cadastral values and the net incomes for agricultural land use types are as follows: (№ 712, 17.11.1998; № 591, 23.09.1999; № 454, 07.08.2000; № 780, 29.08.2001, № 1488-N, 19.09.2002;

№ 717-N, 13.06.2003; № 1109-N, 05.08.2004; № 879-N, 30.12.2004; № 607-N, 19.04.2007; № 800-N, 24.06.2008; № 29-N, 13.01.2022) refer to Decision № 237 (Decision of the Government of the Republic of Armenia of July 3, 1997 № 237).

The main purpose of the article is to analyze the current cadastral assessment procedure in order to avoid some existing shortcomings when developing a new methodology for the reassessment of agricultural lands in Armenia.

### Materials and methods

The main purpose of land cadastral assessment is regulatory and information support for state regulation of land relations (Varlamov, 2006).

**Table 1.** Land-cadastral zones of RA - by marzes (provinces)\*

Id	Land-cadastral zones of RA	Marzes (provinces) of RA				
		Ararat	Ararat	Armavir	Kotayk	Yerevan
1	Urts-Kotayk-Shamiram	Aragatsotn	Ararat	Armavir	Kotayk	Yerevan
2	Kotayk-Talin	Aragatsotn	Kotayk	Shirak		
3	Aparan-Hrazdan	Aragatsotn	Kotayk	Shirak		
4	Urts-Vayots Dzor	Ararat	Vayots Dzor			
5	Vedi-Nerkin Arpa	Ararat	Vayots Dzor			
6	Sevan	Gegharkunik	Kotayk			
7	Pambak-Nerkin Dzoraget	Lori				
8	Verin Dzoraget	Lori				
9	Verin Debet-Aghstev	Lori	Tavush	Gegharkunik		
10	Akhuryan-Spitak	Shirak	Lori			
11	Syunik	Syunik				
12	Vorotan	Syunik				
13	Nerkin Debet-Aghstev	Tavush	Lori	Gegharkunik		
14	Merdzaraktsyan	Ararat	Armavir	Yerevan		
15	Ashotsk	Shirak				

\*Composed by the authors.

The land-cadastral zoning of the land fund of the RA is a scientific system of dividing territory, which is characterized by the detection of practically homogenous natural, soil and economic conditions and contributes to the correct assessment of agricultural lands (Avagyan and Efendyan, 2022).

The land assessment is expressed in comparative relative indicators which show how good or bad is particular land for growing a particular crop (Yezekyan and Efendyan, 2008).

Over the past two decades, natural landscapes in the territory of RA have undergone noticeable changes, mainly due to anthropogenic intervention, as well as climate change, which has led to a sharp deterioration of the hydrothermal regime, soil fertility indicators, soil degradation and erosion processes over a large part of the territory. Researching the reclamation state of lands and cadastral revaluation will also indirectly contribute to increased soil fertility (Avagyan and Efendyan, 2023).

The state cadastral assessment of agricultural lands enables to determinate the value of land in terms of productivity and soil contamination (Vislinski and Tikhonenko, 2017). Therefore, when conducting a cadastral assessment of agricultural land types, it is necessary to take into

account the technological conditions of the plots, which have a direct impact on the cost of agricultural crops (Yeghiazaryan, et al., 2020).

The land-cadastral assessment zones of the RA are also determined by the annexes to the Decision of the Government of the RA № 237, with fifteen of the zones containing agricultural lands. Below we present the distribution of land cadastral zones by marzes (provinces).

The land-cadastral zones are distributed as shown in figure 1.

The appendix of the Decision of the Government of the RA № 237 shows the net incomes of agricultural lands, by marzes (provinces) and communities, by land use type (arable lands, perennial plantings (vineyards, orchards (pome fruits, stone fruits)), natural rangelands (grasslands, pastures)), and by groups of cadastral assessment (1-5-rd classes). Although the cadastral values and net incomes in Appendix are provided by marzes and communities, the main factor for these values is land-cadastral zoning: the cadastral value of the 5th class arable land of the conditional Urts-Kotayk-Shamiram land-cadastral zone is the same both in Aragatsotn, Armavir, Ararat, Kotayk provinces and in Yerevan.



## LAND-CADASTRAL ZONING OF REPUBLIC OF ARMENIA

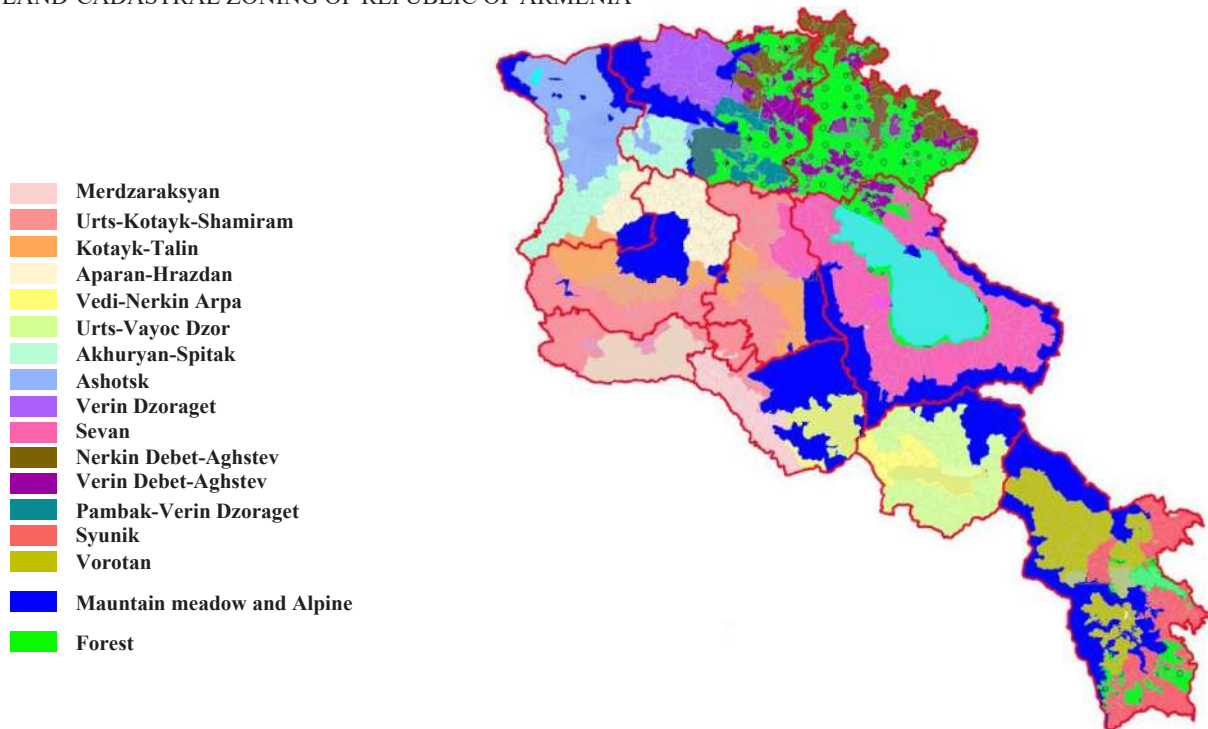

Figure 1. Land-cadastral zoning of RA (Yezekyan, 2014).

## Results and discussions

In the Appendix, the grasslands and pastures are divided into two groups – countryside (adjacent to the villages) and remote; however, the cadastral value is the same in both groups. Only the values of arable lands are divided into irrigated and non-irrigated groups. For all other land use types, the values for irrigated and non-irrigated areas are identical. In the Appendix, the values of the catastrophe groups of those lands are provided per communities that were present in the particular community at that time. Values of absent land use types and those of the absent land cadastral assessment groups are not presented.

According to the Decision of the Government of the RA № 1101-N of July 25, 2002 “On approval of the cadastral values of other agricultural lands”, other (unused) lands of agricultural designation are assessed separately for each land-cadastral zone, calculated by the coefficient determined for the particular year based on the Decision of the Government of the RA № 1101-N, from the lands of agricultural designation, by the net incomes and cadastre values weighted by land areas of the 5th group pasture lands (Decision of the Government of the Republic of Armenia № 1101-N of July 25, 2002).

Based on the aforementioned decisions of the Government of the RA, we have drawn up the table below, separating

the values defined for each land-cadastral zone. For this purpose, we have analyzed statements of cadastral values and net incomes for 1002 settlements and obtained a complete table for all groups of land-cadastral assessment for all land use types in all 15 land-cadastral zones, which didn't exist before. The fields, the values of which are not provided in the Appendix to the Decision, remained empty, i.e. no value was determined for them.

Obviously, in all the land-cadastral zones, the highest values have the perennial plantings, followed by arable lands, grasslands, pastures and other lands. In Urts-Kotayk-Shamiram and Urts-Vayots Dzor land-cadastral zones, pome fruit orchards are the highest value lands, while vineyards have the highest value in Vedi-Nerkin Arpa, Verin Debed-Aghstev, Syunik, Vorotan and Sub-Araks land-cadastral zones, and stone fruit areas are most valued in Nerkin Debed-Aghstev zone.

Grasslands in some regions are inferior in value to arable lands (Urts-Kotayk-Shamiram, Vedi-Nerkin Arpa, Sevan, Pambak-Nerkin Dzoraget, Verin Dzoraget), and in others (Kotayk-Talin, Aparan-Hrazdan, Urts-Vayots Dzor) have a higher value. Exactly, the same picture is in the case of pastures.

The values of the other lands correspond to pastures of the 5<sup>th</sup> class.

**Table 2.** The cadastral assessment values – by land-cadastral zoning, land use types and groups of cadastral assessment, according to the Decisions № 237 of 1997 and № 1102-N of 2002 of the Government of the Republic of Armenia.

Land cadastral zones	land use type	arable lands					stone fruit orchards					pome fruit orchards					vineyards					grasslands					pastures					other lands					
		1	2	3	4	5	1	2	3	4	5	1	2	3	4	5	1	2	3	4	5	1	2	3	4	5	1	2	3	4	5						
Urts-Kotayk-Shamiram	groups of cadastral assessment	145900	88400	63800	47400	14600																															
	cadastral value, for 1 ha, irrigated																																				
Aparan-Hrazdan	cadastral value, for 1 ha, irrigated	71400	59100	46800	27100	14800																															
	cadastral value, for 1 ha, non-irrigated	35300	30400	23000	14800	9800																															
Vedi-Nerkin Arpa	cadastral value, for 1 ha, irrigated	66700	52800	32300	16700																																
	cadastral value, for 1 ha, non-irrigated	35300	30400	20500	9800																																
Pambak-Nerkin Dzoraget	cadastral value, for 1 ha, irrigated	37900	28900	24000	13300																																
	cadastral value, for 1 ha, non-irrigated	21300	17200	13100	6600																																
Verin Debet-Aghstev	cadastral value, for 1 ha, irrigated	63100	45800	27800	11300																																
	cadastral value, for 1 ha, non-irrigated	24600	15600	14000	9100																																
Syunik	cadastral value, for 1 ha, irrigated	90300	73900	60700	38600																																
	cadastral value, for 1 ha, non-irrigated	49300	40200	25400	10700																																
Nerkin Debet-Aghstev	cadastral value, for 1 ha, irrigated	114900	82100	57500	41000	24600																															
	cadastral value, for 1 ha, non-irrigated	59100	45100	27100	14800																																
Ashotsk	cadastral value, for 1 ha, irrigated	106700	82100	57500	41000																																
	cadastral value, for 1 ha, non-irrigated	82100	60700	46000	32800	12300																															
Kotayk-Talin	cadastral value, for 1 ha, irrigated	81100	64700	48300	23600																																
	cadastral value, for 1 ha, non-irrigated	65700	60700	46000	32800	11500																															
Urts-Vayots Dzor	cadastral value, for 1 ha, irrigated	98800	75800	56900	38000	16700																															
	cadastral value, for 1 ha, non-irrigated	37800	32000	27100	20500	9800																															
Sevan	cadastral value, for 1 ha, irrigated	87300	64300	41300	24900	13400																															
	cadastral value, for 1 ha, non-irrigated	29500	25400	21300	17200	9000																															
Verin Dzoraget	cadastral value, for 1 ha, irrigated	79700	65700	52600	31200	16500																															
	cadastral value, for 1 ha, non-irrigated	41900	36100	23800	17200	9800																															
Akhuryan-Spitak	cadastral value, for 1 ha, irrigated	106200	67600	37200	12600																																
	cadastral value, for 1 ha, non-irrigated	52500	37800	26200	10700																																
Vorotan	cadastral value, for 1 ha, irrigated	203800	179200	121800	80700	39700																															
	cadastral value, for 1 ha, non-irrigated	32800	27900	22200	15600																																
Merdzaraktsyan	cadastral value, for 1 ha, irrigated	61600	59900	48500	25700	18100																															
	cadastral value, for 1 ha, non-irrigated	38600	25400	15600	8200																																

\*Composed by the authors.

The values of land-cadastral zoning (for 1 ha, measurement – AMD, by land-cadastral zoning, land use types and groups of cadastral assessment) as well as the gap values which were not determined for many land-cadastral zones

and groups of cadastral assessment, can be seen more clearly and obviously in the figures 2 to 9 below, presented for each operational goal.

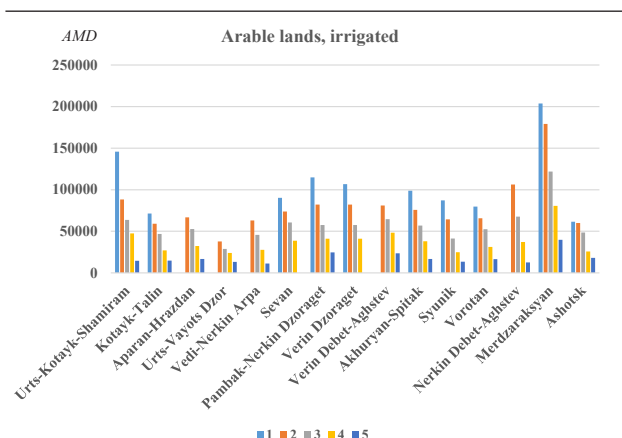

**Figure 2.** The cadastral values of irrigated arable lands – by land-cadastral zones and groups of cadastral assessment (composed by the authors).

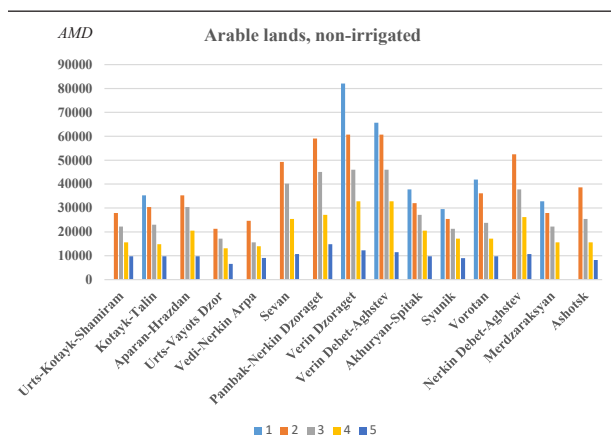

**Figure 3.** The cadastral values of non-irrigated arable lands – by land-cadastral zones and groups of cadastral assessment (composed by the authors).

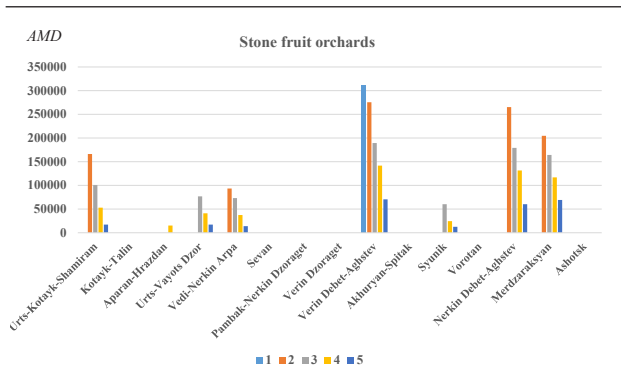

**Figure 4.** The cadastral values of stone fruit orchards – by land-cadastral zones and groups of cadastral assessment (composed by the authors).

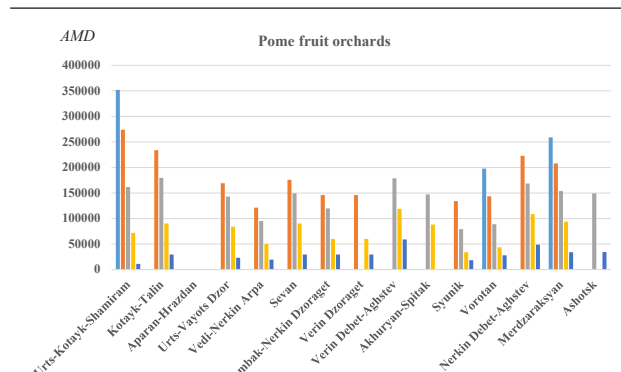

**Figure 5.** The cadastral values of pome fruit orchards – by land-cadastral zones and groups of cadastral assessment (composed by the authors).

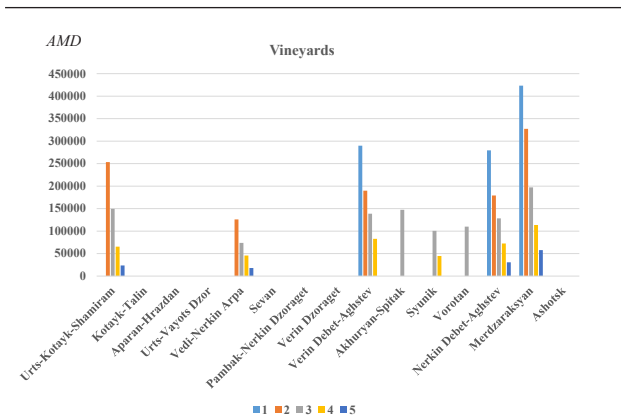

**Figure 6.** The cadastral values of vineyards – by land-cadastral zones and groups of cadastral assessment (composed by the authors).

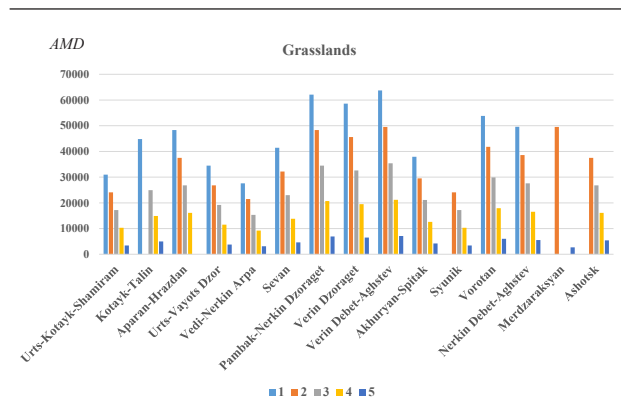

**Figure 7.** The cadastral values of grasslands – by land-cadastral zones and groups of cadastral assessment (composed by the authors).

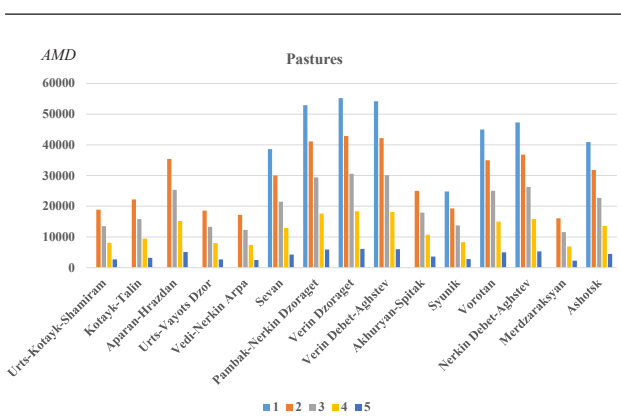

**Figure 8.** The cadastral values of pastures – by land-cadastral zones and groups of cadastral assessment (composed by the authors).

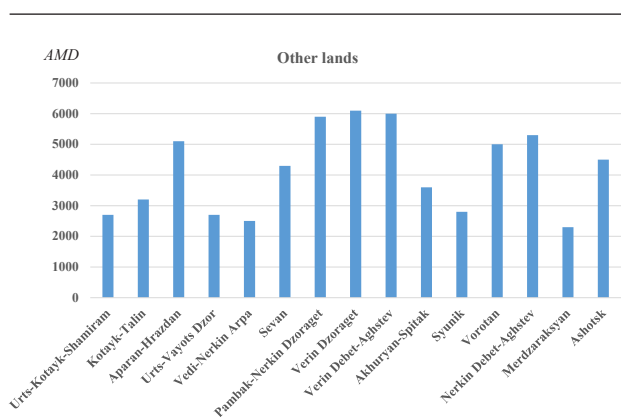

**Figure 9.** The cadastral values of other lands – by land-cadastral zones (composed by the authors).



In some land-cadastral zones, for vineyards (Kotayk-Talin, Aparan-Hrazdan, Urts-Vayots Dzor, Sevan, Pambak-Nerkin Dzoraget, Verin Dzoraget, Ashotsk), for stone fruit orchards (Kotayk-Talin, Sevan, Pambak-Nerkin Dzoraget, Verin Dzoraget, Akhuryan-Spitak, Vorotan, Ashotsk), pome fruit orchards (Aparan-Hrazdan) the cadastral value has not been determined for any group of cadastral assessment. In the case of pastures, the values of the 1st cadastral assessment group are mostly absent (Urts-Kotayk-Shamiram, Kotayk-Talin, Aparan-Hrazdan, Urts-Vayots Dzor, Vedi-Nerkin Arpa, Akhuryan-Spitak, Merdzarakhsyan). In the case of grasslands in different land-cadastral zones, the values of different groups of cadastral assessment are absent (for example, in Kotayk-Talin - 2nd group, in Aparan-Hrazdan - 5th group, in Syunik - values of the 1st group), the same picture is also in the case of arable lands.

### Conclusion

In 6 out of 15 land-cadastral zones, the cadastral value has not been determined for 2 agricultural land types, in 3 - for 1 agricultural land types (for any group of cadastral assessment), and in the case of the remaining six regions, for some groups of cadastral assessment different agricultural land types have not been determined. There is no such region of land-cadastral zones for which the cadastral values and the net incomes of all groups of cadastral assessment for all agricultural land use types are determined.

Currently, if any landowner decides to plant an orchard or a vineyard in the conditional Ashotsk or Aparan-Hrazdan land-cadastral assessment zone, the net incomes and the cadastral values are calculated based on values of one of the nearby land-cadastral zones, which, in our opinion, is incorrect. In the new methodology of cadastral revaluation of agricultural lands, it is necessary to include base values for each agricultural land type for each land-cadastral assessment zone, which will further serve as the basis for calculating the net incomes and the cadastral values for any group of land cadastral assessment for newly established planting of any land type.

The circumstances of determining the same cadastral values and net incomes for nearby and remote grasslands and pastures are also unclear and need additional justifications or changes.

### References

1. Avagyan, M., Efendyan, P. (2022). Assessment and land cadastral circulation of physical-geographical conditions, land formation in the Republic of Armenia, Collection of Scientific articles of Gavar State University, - N 13 (in Armenian).
2. Avagyan, M., Efendyan, P. (2023). Land cadastral characteristics of Gavar area of Gegharkunik region, soil quality, assessment criteria, Collection of Scientific articles of Gavar State University, - N 15 (in Armenian).
3. Decision of the Government of the Republic of Armenia No. 237, dated to July 3, 1997 "On approval of the data of the state land cadaster of agricultural lands and unsuitable lands of the Republic of Armenia" (in Armenian) <https://www.arlis.am/DocumentView.aspx?docID=28610>.
4. Decision of the Government of the Republic of Armenia No. 1101-N dated to July 25, 2002 "On approval of the cadastral values of the agricultural unsuitable lands" (in Armenian) <https://www.arlis.am/DocumentView.aspx?docid=52078>.
5. Law of the RA "On approval of procedure for cadastral assessment approximating to market value of real estate for real estate taxation" (HO-225-N), 2019 (in Armenian) <https://www.arlis.am/documentview.aspx?docid=136988>.
6. Varlamov, A.A. (2006). Land cadastre, Volume 4, Land assessment, Moscow, Koloss, - 463 p. (in Russian).
7. Vislinski, M.D., Tikhonenko, V.V. (2017). About state cadastral assessment of lands of populated areas and agricultural lands, Russian Law, N 1, 2017 y (in Russian).
8. Yeghiazaryan, G.M., Ghazeyan, K.A., Aleksanyan, A.A. (2020). Features of the cadastral valuation of agricultural land on the example of the consolidated community of Gladzor, Public Administration, - N 1, 2020 y (in Armenian).
9. Yezeqyan, A.S. (2014). The cadastral assessment of agricultural lands, Yerevan, ANAU, - 128 p. (in Armenian).
10. Yezeqyan, A.S., Efendyan, P.S. (2008). Land cadastre, Yerevan, ASAU, - 284 p. (in Armenian).

### Acknowledgements

*These analyses were carried out with the financial support of Higher Education and Science Committee of the Ministry of Education, Science, Culture and Sport of RA – within the frame of the scientific topic coded 21T-4C249.*

Accepted on 27.11.2023  
Reviewed on 22.12.2023



UDC 635.63:[631.24:632]

## Studying Stimulant and Fungicidal Properties of Preparation “Argitos Agro” against Powdery Mildew in Greenhouse Conditions

L.H. Atchemyan, V.S. Mirzoyan, N.K. Petrosyan, G.A. Karapetyan

Scientific Center for Risk Assessment and Analysis in Food Safety Area, RA

[levonachemyan.41@gmail.com](mailto:levonachemyan.41@gmail.com), [varsik\\_mir@yahoo.com](mailto:varsik_mir@yahoo.com), [nelli3591@gmail.com](mailto:nelli3591@gmail.com), [gabrielkarapet@gmail.com](mailto:gabrielkarapet@gmail.com)

### ARTICLE INFO

#### Keywords:

*plant growth stimulant,  
“Argitos Agro”,  
powdery mildew,  
fungicidal property,  
crop quality*

### ABSTRACT

“Argitos Agro” is a plant growth stimulant with fungicidal effect and when disinfecting cucumber seeds and applying during the growing season, it does not have a significant effect on the development of powdery mildew disease.

The preparation, indeed, has a stimulating effect on the germination of cucumber seeds, the growth of seedlings and plants, accelerates flowering, increases the yield and improves its quality indicators.

### Introduction

Currently, a lot of attention to the implementation of high technologies, including in agriculture, is paid all over the world (Singh, et al., 2017; Duhan, et al., 2017).

Recently, growth stimulant with fungicidal properties, namely preparation Argitos Agro produced by the scientific production enterprise “Nanosphere” of the Russian Federation has been registered in our Republic, the basis of which is the use of an ionic solution of nanosilver.

The preparation is intended for stimulating the growth and metabolism of plants, disinfection of soil, seeds and planting material (bulbs, tubers, roots), as well as prevention and immediate control of a number of diseases.

The stimulating effect of the preparation on the plant is due to the fact that colloidal nanosilver ions reduce its sensitivity to ethylene by suppressing ethylene receptors. As a result, premature aging of plants is inhibited and yield

increases. In addition, colloidal silver ions increase the concentration of endogenous auxins in plant tissues at the expense of suppressing the activity of enzymes carrying out their oxidation, as a result of which a powerful root system is formed, thereby promoting growth and development of plants (Sharma, et al., 2012; Aung, et al., 2021).

Involvement of such a preparation in organic agriculture is very necessary, because in our deep conviction, the development of the greenhouse economy in our Republic should go mainly in the direction of the production of organic vegetables, fruits and greens from now on.

Based on the above stated, the aim of this work was to study the effect of the preparation Argitos Agro on the germination of cucumber seeds grown in greenhouse conditions, on plant growth, development, yield and quality indicators of fruits, as well as to study the potential role of the preparation in powdery mildew disease management.

## Materials and methods

The experiments were carried out in the greenhouse economy of Darakert community at Masis region.

Before sowing, part of the seeds was kept for 10 hours in a 0.5 % solution of the preparation “Argitos Agro”, some other part was treated in a 1.0 % solution of the preparation, and another part was left untreated.

The seeds were sown in plastic cups, and in order to stimulate the germination process, they were covered with a polyethylene film, making ventilation from time to time. In the initial period, cups were kept at  $+(26-27)^{\circ}$ , which was then gradually lowered: during the day:  $+(20-22)^{\circ}$ , at night:  $+(15-17)^{\circ}$ .

As soon as the first sprouts of the seeds appeared, the polyethylene film was removed.

Seedlings were planted one month after sowing, 2.5 plants per square meter. In order to stop the further growth of the plants and regulate the yield, the ends of the main stem of the 90-day-old plants were cut off.

During the vegetation period, the plants (including the control) were fed 3 times a week after planting, with the help of the drip system, with fertilizers intended for growing cucumbers. The first feeding was done one week after planting the seedlings (20 g urea, 10 g potassium sulfate, 10 g super-phosphate per 10 L of water), the second one – during mass flowering (30 g urea, 20 g potassium sulfate and 40 g super-phosphate per 10 L of water), the third one – during fruiting (20 g nitro-phosphate, 20 g potassium sulfate and 1 liter of manure infusion per 10 L of water). It should be also noted that during the preparation of the soil, it was enriched with bio-humus.

During the vegetation period, the plants were also sprayed twice with preparation “Argitos Agro”. The first spraying was done one week after planting the seedlings, the second - 15 days after the first spraying. That is, as recommended by the instructions for the use of the preparation for cucumbers.

Experiments were performed as follows:

1. Seeds were not disinfected and the plants were not sprayed with a stimulant during vegetation (Control);
2. The seeds were not disinfected and the plants were sprayed twice with a 1.0 % colloidal silver solution during the vegetation period;
3. Seeds were disinfected with a 0.5 % solution of colloidal silver and the plants were sprayed twice with a 1.0 % solution of colloidal silver;
4. Seeds were disinfected with a 1.0 % solution of

colloidal silver and the plants were sprayed twice with a 1.0 % solution of colloidal silver.

Observations related to the plants infection degree by powdery mildew were carried out with the methods accepted in phytopathology (Shamray and Glushenko, 2006).

Biometric observations of plants were made using the accepted methods (Bukharova, 2021).

The qualitative indicators of the fruits were determined with the methods accepted for biochemical analysis (Yermakov, et al., 1987). Dry matter in fruits was determined by drying the samples in a thermostat at 100-105 °C until constant weight was reached. Total acidity was determined by the titration method, ascorbic acid (vitamin C) - by Murre’s method, and sugars - by the Bertrand’s method.

**Statistical analysis:** *The data for yield were analyzed by applying Anova Single Factor Test at 95% confidence level for 4 replicates.*

## Results and discussions

Observations made during the vegetation period showed that no signs of powdery mildew or any other disease appeared on cucumber plants within 50 days after germination. Later, only signs of the powdery mildew disease began to appear on the leaves of the plants that gradually became stronger and more widespread, and more intensively in the control version (Table 1).

**Table 1.** Effect of Argitos Agro on the development of powdery mildew disease in cucumber plants\*

Variants	Infection rate, %		
	Days after seed treatment		
	50	70	90
Untreated seeds and plants (Control)	0.0	5.2	12.2
The seeds were not disinfected but the plants were sprayed with a 1.0 % stimulant solution during the vegetation	0.0	4.4	11.0
The seeds were disinfected with a 0.5 % solution of the stimulant and the plants were sprayed with a 1.0 % solution during the vegetation	0.0	3.5	7.4
The seeds were disinfected with a 1.0 % solution of the stimulant and the plants were sprayed with a 1.0 % solution during the vegetation period	0.0	3.0	6.4

\*Composed by the authors.

**Table 2.** Biometric data of cucumber plants\*

Variants	Flowering after sowing, day	Germination after sowing, days	Seedling length before planting, cm	Length of the main stem, cm		
				50	70	90
Untreated seeds and plants (Control)	49	4	18	65	110	182
The seeds were not disinfected but sprayed with a 1.0 % stimulant solution during the vegetation	47	4	18	70	115	186
The seeds were disinfected with a 0.5 % solution of the stimulant and sprayed with a 1.0 % solution during the vegetation	45	3	20	74	122	192
The seeds were disinfected with a 1.0 % solution of the stimulant and sprayed with a 1.0 % solution during the vegetation	45	3	22	78	128	200

\*Composed by the authors.

Table 1 clearly shows that the preparation Argitos Agro inhibits the development of the disease to some extent. During the vegetation the seeds were not disinfected with the preparation, but after repeated sprayings with the stimulant, the infection rate on the leaves of 70-day-old plants was 0.8 % lower than in the plants of the control variant. Within the same period, the spread of the disease in the disinfected and sprayed versions decreases by 1.7-2.2 %. A similar pattern is also observed after 90 days. In the specified period, the intensity of the disease on the leaves of plants compared to the control decreases by 1.2 % in the non-disinfected and sprayed version, and by 4.8-5.8 % – in the disinfected and sprayed versions.

In order to prevent the further spread of the powdery mildew on the cucumber plants, they were completely sprayed twice with Bayleton. The obtained data prove that even the disinfection of the seeds and repeated application of Argitos Agro during the vegetation does not have a significant effect on the development of powdery mildew disease.

The ineffectiveness of the stimulant is also mentioned in the literature on wheat (Lin and Xing, 2007) and in the informative summary of the preparation application. It is also noted that the effectiveness of the preparation against a number of diseases (bacterial burn, stem rust, reddish-gray spotting, root rot, powdery mildew) of different crops is high.

In order to clarify the stimulating effect of the preparation Argitos Agro, we performed biometric observations.

The data in Table 2 show that the preparation really has stimulating properties on the cucumber. Cucumber seeds disinfected with the stimulant germinate 1 day earlier than those that are not disinfected. The preparation stimulates

the growth of seedlings and contributes to the earlier flowering of shoots. Moreover, before the planting, the length of the seedlings in the versions disinfected and double sprayed with the stimulant was 2-4 cm longer than in the control one. Compared to the latter, flowering of the plants begins 2-4 days earlier.

The stimulating effect of Argitos Agro on cucumber plants is manifested during the entire vegetation period. The length of the main stem of 90-day-old plants is 10-18 cm longer in the stimulant versions compared to the control. Even if the seeds are not disinfected and the stimulant is used during the vegetation, the length of the plants increases by 4 cm.

**Table 3.** Yield of cucumber as affected by the use of Argitos Agro preparation\*

Variants	Yield (kg/m <sup>2</sup> ) LSD =1.09
Untreated seeds and plants (Control)	15.2±1.30
The seeds were not disinfected but plants were sprayed with a 1.0 % stimulant solution during the vegetation	17.2±1.46
The seeds were disinfected with a 0.5% solution of the stimulant and plants were sprayed with a 1.0% solution during the vegetation.	19.0±0.90
The seeds were disinfected with a 1.0 % solution of the stimulant and plants were sprayed with a 1.0 % solution during the vegetation.	19.0±0.61

\*Composed by the authors.

**Table 4.** Effect of Argitos Agro stimulant on the main qualitative properties of cucumber\*

Variants	Sugars, %			Organic acids, % (by malic acid)	C vitamin, mg%
	mono- sugars	sucrose	Total		
Untreated seeds and plants (Control)	1.98	0.65	2.63	0.1	5.0
The seeds were not disinfected but plants were sprayed with a 1.0 % stimulant solution during the vegetation	2.41	0.55	2.96	0.1	7.3
The seeds were disinfected with a 0.5 % solution of the stimulant and plants were sprayed with a 1.0 % solution during the vegetation.	2.23	0.74	2.97	0.09	9.0
The seeds were disinfected with a 1.0 % solution of the stimulant and plants were sprayed with a 1.0 % solution during the vegetation.	2.37	0.67	3.04	0.1	10.0

\*Composed by the authors.

A significant increase in yield is observed when the seeds are disinfected with the preparation and the plants are sprayed twice with the stimulant during the vegetation. In these cases, 3.8 kg of additional harvest is obtained from one square meter (Table 3).

The obtained data were analyzed by variance (Anova) with 95 % confidence level. The null hypothesis was rejected ( $P < 0.05$ ,  $F_{obs} > F_{cr}$ ). A statistically significant difference between variants was found.

Biochemical analyzes performed by us have shown that the fruits of all variants, where Argitos Agro was used, stand out with better quality indicators (Table 4). Moreover, the total content of sugars in them is higher than in the control variant by 0.33-0.41 %, and the amount of vitamin C exceeds that of the control one even twice.

These results are confirmed upon the literature, where it is shown that some concentrations of silver nanoparticles have a pronounced phytostimulating effect on plants of rape, poplar and arabidopsis plants (Gusev, et al., 2013; Vance, et al., 2015). The mechanism of phytostimulation can be the suppression of silver nanoparticles in the activity of microflora pathogenic for plants, as well as the inclusion of silver in biochemical processes.

## Conclusion

Summarizing the results of the research related to the effect of Argitos Agro on cucumbers, it can be concluded that the preparation, in the case of seed disinfection and its repeated application during the vegetation, does not have a significant effect on the development of the powdery mildew.

Whereas, the preparation really has a stimulating effect, promotes the germination of cucumber seeds, the growth of seedlings and plants, accelerates flowering and increases the harvest, while providing better quality fruits.

## References

1. Aung, H.N., May, T.S., Swum., Y.K. (2021). Chang Kil Kim. Nano-silver controls transcriptional regulation of ethylene - and senescence-associated genes during senescence in cut carnations. *Scientia Horticulturae*. Volume 287.
2. Bukharova, A.R. (2021). Methodical instructions for studying discipline and tasks for control work. Balashikha, - 31 p. (in Russian).
3. Ermakov, A.I., Arasimovich, V.V., Yarosh, N.P. (1987). *Methods of Biochemical Analysis of Plants*. L.: Agropromizdat, - 430 p. (in Russian).
4. Gusev, A.A., Akimova, O.A., Krutyakov, Y.A., Klimov, A.I., Denisov, A.N., Kuznetsov, D.V. (2013). The influence of fine particles of different nature on the early stages of ontogeny rape plants (*Brassica napus*). Institute of State Administration, Law and Innovative Technologies. Internet-journal "Naukovedenie". № 5, - pp. 1-17 (in Russian).
5. Joginder Singh Duhan, Ravinder Kumar, Naresh Kumar, Pawan Kaur, Kiran Nehra, Surek haDuhan. *Nanotechnology: (2017). The new perspective in precision agriculture. Biotechnology Reports*. Volume 15, - pp. 11-23 <http://dx.doi.org/10.1016/j.btre.2017.03.002>.



6. Lin, D, Xing, B.(2007). Phytotoxicity of nanoparticles: Inhibition of seed germination and root growth. *Environmental Pollutants*, Vol. 150, Iss. 2, - pp. 243-250 <http://dx.doi.org/10.1016/j.envpol.2007.01.016>.
7. Saurabh, S., Bijendra, K.S., Yadav, S.M., Gupta, A.K. (2015). Applications of Nanotechnology in Agricultural and their Role in Disease Management. *Research Journal of Nanoscience and Nanotechnology*, Volume 5 (1), - pp.1-5 <http://dx.doi.org/10.3923/rjnn.2015.1.5>.
8. Shamrai, S.N., Glushchenko, V.I. (2006). Basics of field studies in phytopathology and phytoimmunology. Kharkiv, - 64 p. (in Russian).
9. Sharma, P., Bhatt, D., Zaidi, M.G.H. (2012). Silver nanoparticle-mediated enhancement in growth and antioxidant status of Brassica juncea. *Appl. Biochem. Biotechnol*, 167, - pp. 2225–2233 <http://dx.doi.org/10.1007/s12010-012-9759-8>.
10. Vance, M.E., Kuiken, T., Vejerano, E.P., McGinnis, S.P., Hochella, M.F., Rejeski, D., Hull, M.S. (2015). Nanotechnology in the real world: Redeveloping the nanomaterial consumer products inventory. *Beilstein J. Nanotechnol*, 6, - pp. 1769–1780 <http://dx.doi.org/10.3762/bjnano.6.181>.

---

*Accepted on 16.10.2023*

*Reviewed on 15.11.2023*



UDC 634.5:[631.674.6:631.82]

## The Effect of Applying Mineral Fertilizers Through Drip Irrigation and Furrow Method on the Movement of Mobile Nutrients in the Soil and the Growth, Development, and Accumulation of Nutrients in the Walnut Leaves

G.H. Gasparyan, S.K. Yeritsyan, L.S. Yeritsyan

*“H. Petrosyan Scientific Center of Soil Science, Melioration and Agrochemistry”, ANAU*

G.S. Santrosyan

*“Voskehat Educational and Research Center of Enology”, ANAU*[gayanchgasparyan@gmail.com](mailto:gayanchgasparyan@gmail.com), [s\\_yeritsyan@yahoo.com](mailto:s_yeritsyan@yahoo.com), [lusineyeritsyan1969@gmail.com](mailto:lusineyeritsyan1969@gmail.com), [santros\\_gagik@mail.ru](mailto:santros_gagik@mail.ru)

### ARTICLE INFO

**Keywords:**

*drip and furrow methods of fertilization, growth of shoots, lignification, movement of nutrients, walnut tree*

### ABSTRACT

A task was set to reveal the effect of water-soluble fertilizers of new composition and quality on the content of available nutrients at different depths of the soil, depending on the movement of the irrigation water, irrigation time, as well as its effect on the growth, yielding capacity and the quality of fruit in commercial size walnut orchards. The research has shown that the movement of nutrients in the soil is completely dependent on the movement of water when applying water-soluble complex fertilizers with drip irrigation. Therefore, the amount of the water should be adjusted so that the nutrients are available to the plant's root system at all depths, improving the growth, and increasing the content of the basic nutrients in the leaves. Fertilizers with less water-solubility are mainly preserved at a 0 cm - 30 cm depth. When the root system grows and spreads to the inter-row spaces, it is appropriate to periodically fertilize also the inter-row spacing by the furrow method.

### Introduction

The importance of fertilizers in maintaining the fertility of soils and increasing the yielding capacity of crops is well known (Melkonyan, et al., 2004; Ghazaryan, et al., 2022; Grigortsevich, 2011; Marchenko, et al., 2015; Mineyev, 2004; Polukhina, et al., 2018). It is common to define the

plant nutrient supply through the chemical analysis of soil or plants (Ghazaryan, et al., 2022; Kuzin, 2015; Mineyev, 2004). In Europe, the USA, Japan, and other countries, it is more common to determine the plant nutrient supply through the plant analysis method. Moreover, the most sensitive organ – the leaf – is mostly analyzed (Volkova,

2019; Gorman, et al., 2021; Michurin, 1973; Yagodin, 1987), with the results being evaluated in three degrees of supply: “week”, “medium” and “good” supply of a particular nutrient. In developed countries, based on the results of numerous studies, a scale of the nutrient supply in soils and plants has been defined. Whereas in Armenia, only a scale of soil nutrient supply is defined (Melkonyan, et al., 2004; Ghazaryan, et al., 2022).

Walnut (*Juglans. L*) is a crop that produces strong aboveground and root systems; however, this occurs, if the soil contains the necessary amounts of nutrients and moisture (Mineyev, 2004; Trunov, 2005; Trusheva, 2014). Moreover, it has been proven that the expected age of the walnut (or other tree types) to bear fruits, the yielding capacity, and the quality of fruit, depends, among other factors, especially on the level of soil fertility. It can be checked by soil and plant (leaf) analysis, followed by setting the fertilizer application rates based on these data (Fomenko, et al., 2018; Trusheva, 2014; Polukhina, et al., 2018; Yagodin, 1987).

Even with all things considered, it should be noted that scientific studies on the fertilization of walnuts are extremely rare, with the Republic of Armenia nearly lacking such studies (Trunov, 2005; Trusheva, 2014; Fomenko, et al., 2018).

Currently, commercial-scale walnut orchards are being massively established in different climatic conditions in Armenia. Their fertilization is later performed through drip irrigation, using mainly water-soluble complex fertilizers, such as N:P: K=20:20:20 + microelements, N:P: K=6:14:35, etc., which, with the changes they have undergone in the soil, differ from the changes of phosphorus, potash and combined and complex fertilizers that are not completely water-soluble. Complex fertilizers well dissolved in water have been imported to Armenia only in recent years. However, their movement and changes in the soil have not been studied yet. Thuswise, it is important to reveal the effect of such fertilizers (NPK) on the content and movement of available nutrients in the soil, according to the depth and width, depending on the movement of the irrigation water and the time of irrigation, as well as its effect on the growth of walnut, NPK content in the leaves and the yielding capacity.

## Materials and methods

The research was carried out in the Aygehat community, Lori Marz, in two different land plots: 1. a two-year-old non-yielding orchard and 2. a six-year-old orchard, just starting to bear fruits, with a plantation density of 35 m<sup>2</sup>

(7 m x 5 m), and Fernor being the pollinated variety and Chandler – the pollinator.

The field trials were performed in 2021-2022, in four replicates, with 10 trees of similar growing capacity selected for each replicate, which were numbered. All the observations, measurements, and records were performed on these plants according to the methodology proposed by Michurin in 1973 (Michurin, 1973).

The trials were set up with the following versions:

### *Trial I – Two-year old orchard*

1. Without fertilization (control version)
2.  $N_{60}$  ammonium nitrate + carbamide + ammonium sulphate (drip method)
3.  $N_{60}P_{60}$  ammonium dihydrophosphate + ammonium nitrate, carbamide (drip method)
4.  $N_{60}P_{60}K_{60}$  20:20:20 (drip method)
5.  $N_{60}P_{60}K_{60}$  20:20:20 (drip method) +  $N_{60}P_{60}K_{60}$  ammonium nitrate + carbamide + double superphosphate + potassium chloride, (furrow method), from both sides of the row, 28 cm – 30 cm deep.

*Trial II – Six-year-old orchard starting to bear fruits. The distance between the plot of this trial from that of Trial I is 12.5 km.*

1. Without fertilization (control version)
2.  $N_{120}$  ammonium nitrate + carbamide + ammonium sulphate (drip method)
3.  $N_{120}P_{120}$  ammonium dihydrophosphate + ammonium nitrate, carbamide (drip method)
4.  $N_{120}P_{120}K_{120}$  20:20:20 (drip method)
5.  $N_{120}P_{120}K_{120}$  20:20:20 (drip method) +  $N_{120}P_{120}K_{120}$  ammonium nitrate + carbamide + double superphosphate + potassium chloride (furrow method), from both sides of the row, 28 cm – 30 cm deep.

According to the trial versions, for drip irrigation, water-soluble complex fertilizers intended for that purpose were applied; in version 5, the fertilization was carried out by drip and furrow methods: For the furrow method, fertilizers intended for applying through overall, furrow, or other methods were applied. The time of each irrigation, depending on the growth stage of the plant has been determined whenever the soil moisture was 60 %-75 % of the maximum field water capacity. To present the agrochemical characteristics of the test plots, the mechanical composition of the soil was determined by the method of Kachinski; humus – by the method of Tyurin; carbonates – by calcimeter; the absorbed calcium and magnesium – by the trilonometric method; the content



of mobile nitrogen was determined by the method of Tyurin-Kononova, that of mobile phosphorus – by the method of Machigin, the content of mobile potassium – in the Machigin solution extract; and humidity – by the weight method (Arinushkina, 1961).

To determine the total amounts of nitrogen, phosphorus, and potassium in the plant's leaves, the related portion was burned in an acidic medium, then the amount of the nitrogen was determined by distillation, phosphorus – with the help of colorimetric photometer and the potassium – with the help flame photometer (Yagodin, 1987). The growth and the lignification of one-year-old shoots of the plant were determined by the linear measurement method (Michurin, 1973).

## Results and discussions

The field trials were carried out on brown forest carbonate soils, the characteristics of which are presented in Tables 1 and 2. Thus, according to the data of Table 1 (trial No. 1, two-year-old orchard), the content of humus in soil was 0.96 %–4.01 %, with the mechanical composition in the upper layers being light loam (physical clay: 25.3 % – 28.8 %), in the 3rd layer – heavy loam (the physical clay: 51.4 %), soil reaction (*pH*) is light alkaline, content of carbonates is 1.2 % – 9.8 %, that of the absorbed calcium – 19.0 mg-eq. – 26.3 mg-eq. and that of magnesium

9.4 mg-eq. – 11.7 mg-eq. in 100 grams of soil. The amount of available nitrogen, phosphorus, and potassium, according to the scale defined for the soils of the RA, is low and decreases further depending on the depth. This situation with the soil nutrient supply is characteristic also of the soils in the entire region; therefore, the need for applying fertilizers is very high (Melkonyan, et al., 2004; Michurin 1973).

The data in Table 2, providing the characteristics of the soils in Trial No. 2 (six-year-old orchard), indicate that the agrochemical characteristics of these soils are considerably different from the data of Trial No. 1, which is due to the application of bio humus and mineral fertilizers for years on about 14 hectares of the orchard before our trials.

According to the data of this table, the mechanical composition of the soil in the upper horizons is light clay, with heavy loam in the lower horizon, the content of carbonates is 3.1 % - 6.9 %, and *pH* – weak alkaline.

The content of available nitrogen is very low, with an almost high content of phosphorus in the upper horizon and a very low content of it in the depths of 30 cm–60 cm and 60 cm–100 cm. According to the depths, such a pattern is observed also in the content of mobile potassium. This state of the nutrients in the test plot is due to incorrect fertilization and irrigation operations. According to the field studies, these soils are hardened starting with 15 cm–20 cm depths, and are difficult to dig when drying.

**Table 1.** The agrochemical characteristics of the soil in Trial No. 1 before fertilization (two-year-old orchard)\*

Sampling depth	Physical clay, %	Humus, %	CaCO <sub>3</sub> , %	pH	Soluble salts, %	Absorbed Ca+Mg mg/eq. in 100 g of soil	Available nutrients of plants, mg in 100 g of soil		
							N	P <sub>2</sub> O <sub>5</sub>	K <sub>2</sub> O
0-30	23.5	4.01	1.2	7.9	0.021	26.3+11.3	3.61	0.47	14.54
30-60	28.8	2.05	7.5	8.4	0.034	21.8+11.7	2.03	0.31	9.81
60-90	51.4	0.96	9.8	8.5	0.038	19.0+9.4	1.40	0.25	5.26

**Table 2.** The agrochemical characteristics of the soil in Trial No. 2 before fertilization (six-year-old orchard)\*

Sampling	Physical clay, %	Humus, %	CaCO <sub>3</sub> , %	pH	Soluble salts, %	Absorbed Ca+Mg mg/eq. in 100 g of soil	Available nutrients of plants, mg in 100 g of soil		
							N	P <sub>2</sub> O <sub>5</sub>	K <sub>2</sub> O
0-30	65.4	4.42	3.1	7.7	0.046	30.1+10.3	1.39	5.60	47.94
30-60	60.8	3.18	5.7	7.8	0.031	21.2+10.4	1.02	1.26	4.23
60-90	56.5	0.73	6.9	8.4	0.028	20.8+9.9	1.04	0.51	4.71

\*Composed by the authors.

Thus, the results of the analyses of the soils in trial plots have revealed that these soils are in the favorable range for the plants with their mechanical composition, pH, and content of carbonates, dissolved salts and the absorbed calcium and magnesium, while by the content of mobile nutrients, the soil in Trial No. 1 is weakly supplied with NPK at all 3 depths, and the soil in Trial No. 2 is poorly supplied with nitrogen, while it is well supplied with phosphorus at the depth of 0 cm-30 cm and poorly supplied at depths of 30 cm-60 cm and 60 cm-90 cm.

Tables 3 and 4 present the effect of fertilizers applied through drip irrigation (versions 2-4) and drip and furrow method (version 5) on the content of nutrients at different depths of soils. According to the data of these tables, in both trials, the fertilizers have had a significant effect on the content of mobile NPK in soil, with the level of impact being dependent on the version of fertilization and the year of trial.

**Table 3.** The effect of fertilizers applied through drip irrigation and drip-furrow method on the content of mobile nutrients in the soil, Trial No. 1\*

Versions	Depth, cm	Mobile nutrients, mg in 100 g of soil					
		2021			2022		
		N	P <sub>2</sub> O <sub>5</sub>	K <sub>2</sub> O	N	P <sub>2</sub> O <sub>5</sub>	K <sub>2</sub> O
1	0-30	2.15	0.41	14.33	2.06	0.41	13.81
	30-60	1.61	0.28	10.01	1.60	0.25	9.54
	60-90	1.14	0.25	5.17	1.08	0.17	4.36
2	0-30	3.54	0.39	12.64	4.35	0.41	13.14
	30-60	3.06	0.30	9.86	4.07	0.27	9.76
	60-90	1.45	0.22	5.08	2.16	0.16	4.78
3	0-30	3.86	3.41	10.36	5.91	5.77	11.63
	30-60	2.95	3.45	8.31	3.17	4.06	8.01
	60-90	1.76	2.14	6.07	2.93	1.58	5.84
4	0-30	4.06	3.51	25.07	6.17	6.98	44.40
	30-60	2.75	3.41	20.05	3.14	5.71	42.97
	60-90	2.06	1.97	18.8	2.84	4.02	30.08
5	0-30	3.91	3.37	25.78	5.87	6.84	38.11
	30-60	2.63	2.84	19.31	3.14	6.01	37.16
	60-90	1.85	2.01	17.65	2.91	3.86	31.42
6	0-30	21.87	28.6	88.70	50.18	65.88	164.56
	30-60	2.86	3.11	4.02	25.71	4.06	4.79
	60-90	1.95	1.75	3.51	7.65	2.04	4.27

**Note:** Versions: 1. Without fertilization (control version), 2. N<sub>60</sub>; 3. N<sub>60</sub>P<sub>60</sub>; 4. N<sub>60</sub>P<sub>60</sub>K<sub>60</sub>; 5. N<sub>60</sub>P<sub>60</sub>K<sub>60</sub> (drip method) + N<sub>60</sub>P<sub>60</sub>K<sub>60</sub> (furrow method)

\*Composed by the authors.

Thus, according to the data provided in Table 3 (Trial No. 1), in the first year of the study, the content of mobile nitrogen in the control version was lower. In this version, the content of mobile nitrogen became even less in the second year of the trial. This pattern was preserved about the mobile phosphorus and partially mobile potassium. Meanwhile, in the versions with fertilizer application, the mobile amounts of the relevant nutrients in the soil have increased, which can be more clearly seen at depths of 0 cm-30 cm and 30 cm-60 cm. This pattern is preserved also in the second year of the trial, becoming even more explicit with the use of water-soluble complex fertilizers. This indicates that the applied fertilizers have remained mobile in the soil and have moved to the deeper layers with the irrigation water. According to different researchers, water-soluble complex fertilizers are effective also in the case of leaf nutrition (Bayrambekov, et al., 2019; Volkova, 2019; Gorman, et al., 2021; Popova, et al., 2009; Trunov, 2005). Meanwhile, numerous studies indicate that the traditional phosphoric (common and double superphosphates), as well as potassium (potassium chloride) fertilizers, are barely able to move in the soil compared with the mobility of nitrogen fertilizers as well as water-soluble complex fertilizers (Michurin, 1973; Osipov, et al., 2018; Polukhina, et al., 2018). The reason is that the water-solubility of the mentioned phosphoric and potassium fertilizers is low. On the other hand, these fertilizers interact with the soil more easily, with the interaction being even faster in carbonate soils, where pH is higher than 7.0-7.5, since in such soils, phosphorus compounds with low water-solubility are formed, while potassium, especially in loam soils, is partially absorbed by the absorbing complex in a non-exchange form (Ghazaryan, et al., 2022; Osipov, et al., 2018; Polukhina, et al. 2018; Trunov, 2005).

Meanwhile, the fertilizers produced for the purpose of drip irrigation contain surface-active agents that mitigate the possibility of comparatively rapid interaction between the fertilizer and the soil (Ghazaryan, et al., 2022; Popova, et al., 2009). As for ammonium and nitrate ions, it is known that the nitrate ion in the soil moves with no hindrance together with the movement of water, while the movement of ammonium ion slows down as it is partially absorbed by the absorbing complex (Ghazaryan, et al., 2022; Polukhina, et al., 2018; Trunov, 2005).

According to the data in Table 3, the movement of the fertilizer applied by the furrow method is extremely difficult, which is especially the case with phosphoric (double superphosphate) and potassium (potassium chloride) fertilizers and the ammonium ion of the ammonium nitrate (Melkonyan, et al., 2004; Ghazaryan,

et al., 2022; Polukhina, et al., 2018; Popova, et al., 2009), although in this version, the irrigation water was used to ensure the same level of depth of soil moisture as it has been in the drip fertilization versions.

Table 4 provides the effect of fertilizers applied by drip irrigation and furrow method in Trial No. 2 on the content of mobile nutrients at different depths of the soil. According to the obtained data, the fertilizers have contributed to the increase of the amounts of mobile NPK, the size of which, however, just like in Trial No. 1, depends on the sampling depth, type of fertilizer, and the method of application. Thus, in the control (non-fertilized) version of the trial, the content of the available NPK is lower. In the case of applying only nitrogen fertilizer (version 2), the content of mobile

nitrogen in soil has increased partially, which is perhaps more noticeable at the depth of 0 cm-30 cm. in the case of using phosphorus or phosphorus and potassium with nitrogen (version 3, 4), the content of these nutrients has increased, which is especially apparent at the depths of 0 cm-30 cm and 30 cm-60 cm. This indicates that the fertilizers applied through drip irrigation have moved through water also at 30 cm-60 cm and partially 60 cm - 90 cm depths. Meanwhile, in the case of applying fertilizers by the furrow method, mobile nutrients have mainly accumulated at the depths of 0 cm-30 cm and partially 30 cm-60 cm, which, as mentioned, is due to the properties of the fertilizers applied by the furrow method (Ghazaryan, et al., 2022; Trunov, 2005).

From these data, we can conclude once again that fertilizers applied by drip irrigation move more easily with water in the soil compared to fertilizers intended to be applied by the overall, trunk, or furrow method.

It is known that to fully reveal the effect of fertilizers on plants, their effect on plant growth, lignification of annual shoots, and content of nutrients in leaves, as well as on yielding capacity and quality indicators is also studied.

The lignification of the shoots in perennial plantations is important because lignification improves the winter hardiness and frost resistance of plants (Volkova, 2019; Gorman, et al., 2021; Polukhina, et al., 2018; Popova, et al., 2009), and the definition of optimal amounts of nutrients in leaves during the vegetation period allows to find out the plant's nutrient supply and the necessity of fertilization (nutrition) (Volkova, 2019; Mineyev, 2004; Michurin, 1973). The data are presented in Tables 5 and 6.

According to the data of the tables, during the vegetation period, the size of the shoots, the degree of their lignification, as well as the content of NPK in the leaves depend on the fertilization system. Accordingly, the mentioned indicators are lower in the control versions. The effect of fertilizers on the lignification of annual shoots as well as on the content of NPK in the leaves are noticeable. Thus, the shoots were better lignified in cases where, in the fertilization system, in addition to nitrogen, also phosphorus or phosphorus and potassium were used. In the case of applying only nitrogen, lignification of shoots was the least, making only 82 %-83 %, while in the version with application of phosphorus and potassium, it made 91 %-95 %.

The effect of fertilizers is significant also on the content of NPK in leaves (Table 5, 6). According to the data of these tables, the effect is more noticeable in version 5 of Trial No. 2. This is due to two factors.

**Table 4.** Effect of fertilizers applied by drip and furrow method on the content of mobile nutrients in the soil, Trial No. 2\*

Versions	Depth, cm	Mobile nutrients, mg in 100 g of soil					
		2021			2022		
		N	P <sub>2</sub> O <sub>5</sub>	K <sub>2</sub> O	N	P <sub>2</sub> O <sub>5</sub>	K <sub>2</sub> O
1	0-30	3.45	6.12	46.14	2.76	4.76	45.13
	30-60	2.77	1.84	8.82	2.86	2.01	5.86
	60-90	1.94	1.05	4.96	2.76	2.11	4.98
2	0-30	4.36	5.91	46.04	5.33	3.98	40.83
	30-60	2.88	2.01	8.16	4.06	1.95	5.06
	60-90	1.65	2.00	5.94	2.91	2.08	5.04
3	0-30	3.76	7.14	45.91	5.16	6.74	39.74
	30-60	2.85	2.95	7.14	3.74	3.06	8.12
	60-90	2.06	1.98	5.78	2.08	2.01	4.03
4	0-30	5.12	7.06	53.16	5.86	6.12	50.36
	30-60	4.04	3.02	12.08	3.65	4.95	11.46
	60-90	1.93	1.77	4.31	2.08	1.04	4.41
5	0-30	4.96	6.78	57.24	5.81	5.44	53.16
	30-60	4.01	3.48	13.17	3.45	5.06	10.85
	60-90	1.74	1.58	5.08	2.14	1.13	4.05
6	0-30	12.36	31.14	155.11	47.63	67.95	158.91
	30-60	8.04	9.33	13.82	21.14	12.31	10.62
	60-90	5.33	1.95	4.76	4.31	3.52	5.36

**Note:** Versions: 1. Without fertilization (control version), 2. N<sub>120</sub>; 3. N<sub>120</sub>P<sub>120</sub>; 4. N<sub>120</sub>P<sub>120</sub>K<sub>120</sub>; 5. N<sub>120</sub>P<sub>120</sub>K<sub>120</sub> (drip)+ N<sub>120</sub>P<sub>120</sub>K<sub>120</sub> (furrow)

\*Composed by the authors.

**Table 5.** Effect of fertilizers applied by drip and furrow methods on the growth, lignification, and content of NPK in the leaves of the walnut shoots, Trial No. 1\*

Versions	Number of annual shoots	Average growth of shoots, cm	Lignification of annual shoots, %	Content of nutrients in leaves, % (average of two years)					
				The first decade of July			2 <sup>nd</sup> decade of August		
				N	P <sub>2</sub> O <sub>5</sub>	K <sub>2</sub> O	N	P <sub>2</sub> O <sub>5</sub>	K <sub>2</sub> O
1	2.3	24	88	2.24	0.27	1.96	1.26	0.21	1.71
2	3.7	35	82	2.84	0.21	1.74	2.04	0.19	1.56
3	3.6	33	89	2.76	0.48	1.76	1.95	0.38	1.57
4	4.8	34	91	2.71	0.45	1.85	1.91	0.36	2.04
5	4.9	33	92	2.75	0.44	1.83	2.02	0.37	2.05

**Note:** Versions: 1. Without fertilization (control), 2. N<sub>60</sub>; 3. N<sub>60</sub>P<sub>60</sub>; 4. N<sub>60</sub>P<sub>60</sub>K<sub>60</sub>; 5. N<sub>60</sub>P<sub>60</sub>K<sub>60</sub> (drip)+ N<sub>60</sub>P<sub>60</sub>K<sub>60</sub> (furrow).

**Table 6.** Effect of fertilizers applied by drip and furrow methods on the growth, lignification, and content of NPK in the leaves, Trial No. 2\*

Versions	Number of annual shoots	Average growth of shoots, cm	Lignification of annual shoots, %	Content of nutrients in leaves, % (average of two years)					
				Blooming stage			2 <sup>nd</sup> decade of August		
				N	P <sub>2</sub> O <sub>5</sub>	K <sub>2</sub> O	N	P <sub>2</sub> O <sub>5</sub>	K <sub>2</sub> O
1	16.1	52	90	2.38	0.45	2.28	1.94	0.38	1.68
2	18.3	71	83	2.99	0.40	2.19	2.15	0.31	1.47
3	15.4	69	92	2.95	0.51	2.13	2.07	0.40	1.44
4	21.2	68	95	2.86	0.54	2.31	2.11	0.39	1.65
5	23.5	77	96	3.18	0.61	2.33	2.39	0.60	1.71

**Note:** Versions: 1. Without fertilization (control), 2. N<sub>120</sub>; 3. N<sub>120</sub>P<sub>120</sub>; 4. N<sub>120</sub>P<sub>120</sub>K<sub>120</sub>; 5. N<sub>120</sub>P<sub>120</sub>K<sub>120</sub> (drip)+ N<sub>120</sub>P<sub>120</sub>K<sub>120</sub> (furrow).

\*Composed by the authors.

First, the content of available nutrients in the soil of this trial was incomparably higher, which has occurred with fertilization through drip irrigation in the previous years. Secondly, according to our observations, part of the plant roots have grown in the inter-row spaces and are fed also by fertilizers applied through the furrow method.

Considering that the content of NPK in the plant leaves is closely related to the nutrient supply, it is possible to determine through leaf analysis the nutrient supply degrees as “weakly”, “averagely” and “strongly” supplied and determine the fertilization (nutrition) rates. Let us add that the methodology of determining the necessity of fertilization (nutrition) based on leaf analysis is widely used in European countries, the USA, and elsewhere (Fomenko, et al., 2018; Yagodin, 1987).

## Conclusion

Based on the results of the fertilization trials in two- and six-year-old (starting to bear fruits) walnut orchards in 2021-2022, the following conclusions were made:

1. The natural supply of nitrogen, phosphorus, and potassium available for plants in brown forest carbonate soils in the Aygehat and adjacent communities, Lori marz, is very low, so there is a great need to apply appropriate fertilizers.
2. The soils in trials are significantly different from each other in terms of the content of mobile nitrogen, phosphorus, and potassium, since while establishing and further maintenance of the 6-year-old orchard, organic and mineral fertilizers were used. Thuswise, at the beginning of the trials, the soil in Trial No. 1 was poorly supplied



with nitrogen, phosphorus, and potassium available for plants, while the soil in Trial No. 2 was poorly supplied with nitrogen and well supplied with phosphorus and potassium at the depth of 0 cm-30 cm.

3. In the case of applying the water-soluble complex fertilizers through drip irrigation, they move with the water to deeper layers compared with the movement of fertilizers applied by the furrow method, although in both cases the moisture has gone down up to 80cm-90cm deep.

4. In the case of applying an effective fertilization system, the growth and lignification of shoots are enhanced, and the content of NPK increases in the leaves. The latter makes it possible to define through leaf analysis the supply of the particular nutrient at “week”, “medium” and “good” levels and then determine the rates of fertilizer application, under the influence of which the plants enter the fruit bearing stage.

5. The effect of fertilizers applied by furrow method (from both sides of the row) on the growth of walnut, lignification of annual shoots, and the content of NPK in the leaves is noticeable only in the 6-year-old orchard (Trial 2), where the roots of the trees have spread to the interrows and are fed from those areas as well. Therefore, to enhance the efficiency of the producing orchards, in addition to the fertilization by drip irrigation, it is important to periodically perform also fertilization by the furrow method, with significantly cheaper, but effective fertilizers.

6. The results of the chemical analysis of the plant's leaves should be taken as a basis to define the fertilizer application rates.

## References

- Arinushkina, Ye.V. (1961). Guide for chemical analysis of soils (in Russian).
- Bayrambekov, Sh.B., Anishko, M.Yu., Garyanova, Ye.D., Gulyayeva, G.V. (2019). The effect of foliar fertilizers on the productivity of tomato in conditions of the delta of Volga // *Izvestia of the Lower Volga Agro-University Complex: Science and Higher Professional Education*, № 2(54). - pp. 63-68 (in Russian) <http://dx.doi.org/10.32786/2071-9485-2019-02-6>.
- Fomenko, T.G., Popova, V.P. (2018). Fertigation of fruit plantations. Methodological guidelines. Krasnodar: FSBSI (Federal State Budgetary Scientific Institution) North Caucasus Federal Scientific Center for Horticulture, Viticulture and Winemaking, - 51 p. (in Russian) <http://dx.doi.org/10.30679/2219-5335-2023-3-81-67-83>.
- Ghazaryan, H.Gh., Urutyun, V.E., Gasparyan, G.H. (2022). The current state of the soils of Armenia, Yerevan, - 204 p. (in Armenian).
- Gorman, N.V., Bobrenko, I.A., Popova, V.V., Gaydar, A.A. (2021). Management of the nutrition of spring wheat based on plant diagnostics. *Zemledelie (Farming)*. - N 6, - pp. 36-40 (in Russian).
- Grigortsevich, L.N. (2011). Basics of Fruit and Vegetable Growing. Minsk, - 84 p. (in Russian).
- Kuzin, A.I. (2015). Distribution of available phosphorus in the root habitable layer of the soil under the influence of drip irrigation and fertigation in an intensive apple orchard. *Fruit Growing and Viticulture in the South of Russia*. Krasnodar: NCSRFV, N 34(4) (in Russian).
- Marchenko, L.A., Mochkova T.V., Kolesnikova V.A., Kozlova A.I. (2015). The state of production and use of liquid mineral fertilizers in agriculture. *Agricultural Machinery and Technologies*, (6), - pp. 36-41 (in Russian).
- Melkonyan, K.G., Ghazaryan, H.Gh., Manukyan, R.R. (2004). The current ecological state of agricultural lands, the level of land use, improvement of the management system, and the ways to enhance the efficiency in the Republic of Armenia, Yerevan, - 54 p. (in Armenian).
- Michurin, I.V. (1973). Program, and methodology of variety study of fruit, berry, and nut crops. - Michurinsk, - 493 p. (in Russian).
- Mineral nutrition of fruit and berry crops: translated from Eng./ edited by Z. A. Metlitski and L. F. Blinov. - Moscow: Selkhozgiz, 1960. – 520 p. (in Russian).
- Mineyev, V.G., *Agrochemistry // Textbook*. — 2nd edition, updated and revised — M: Publishing House of MSU, KolosS, 2004. - 720 p. (in Russian).
- Osipov, A.I., Shkrabak, Ye.S. (2018). The role of foliar nutrition in the yield and quality of vegetable crops // *Selskokhozyaystvennie Nauki (Agricultural Sciences). Agronomia (Agronomy)*, - pp. 35-41 (in Russian).
- Polukhina, Ye.V., Ivanenko, Ye.N., Morozov, D.Ye., Vlasenko, M.V. (2018). The effect of the foliar fertilizers on economic and price indicators of table grape varieties // *Izvestia of the Lower Volga Agro-University Complex: Science and Higher Professional Education*, - № 4(52), – pp. 185-191 (in Russian).
- Popova, V.P., Fomenko, T.G. (2009). The efficiency of drip irrigation with the application of mineral fertilizers

- in apple tree plantations. Sadovodstvo i vinogradarstvo ("Fruit Growing and Viticulture"), - pp. 2-5 (in Russian) <http://dx.doi.org/10.31676/0235-259i-20i9-2-i0-i7>.
16. Trunov, Yu.V. (2005). Mineral nutrition of fruit crops and the balance of elements in agroecosystems // Vestnik of the Russian Agricultural Sciences, No. 2, - pp. 55-58. (in Russian).
17. Trusheva, N.A. (2014). A Study of the dynamics of growth and development of the walnut fruit. Maykop, - 21 p. (in Russian).
18. Volkova, A.V. (2019). The Market of Mineral Fertilizers / National Research University. Graduate School of Economics. - 52 p. (in Russian).
19. Yagodin, B.A. (1987). Tutorial on Agrochemistry. – M., Agropromizdat, -512 p. (in Russian).
20. Yesayan, G.M.(1984). Walnut growing: Yerevan, - 68 p. (in Armenian).

---

*Accepted on 07.09.2023*

*Reviewed on 17.10.2023*



UDC 633.11:631.82

## The Effect of Various Tillage Methods and Meliorants Application against their Background on the Dynamics of Macronutrients Accumulation in the Winter Wheat Plants and their Output via Crop Yield

K.A. Gharakhanyan, M.H. Galstyan

Armenian National Agrarian University

[karen.gharakhanyan97@gmail.com](mailto:karen.gharakhanyan97@gmail.com), [galstyan.merujan@mail.ru](mailto:galstyan.merujan@mail.ru)

### ARTICLE INFO

**Keywords:**

soil tillage,  
meliorants,  
biohumus,  
bentonite,  
nutrient dynamics

### ABSTRACT

The article presents the results of two-year investigations related to the effect of different soil cultivation methods, application times of equal doses of mineral and organic fertilizers and bio-humus with bentonite application against their background on the dynamics of macronutrients accumulation and their removal/output through the crop yield. Considering the changes in the winter wheat growth, development, and yield capacity under the effect of different soil tillage methods, as well as the applied fertilizers and bentonite in rainfed conditions, and also the nutrition characteristics, to get high and sustainable yield the cultivation of winter wheat should be implemented only through loosening method, while fertilization should be implemented by introducing natural rock bentonite into the soil either on the background of mineral fertilizers ( $N_{60}P_{60}K_{60}$ ) or bio humus (3.5 t/ha) in autumn, as a result of which the soil air, nutrition and humidity regimes improve, favorable conditions are created for the regular growth and development of the plant and 48.8-52 c/ha grain and 89-96 c/ha straw yield is ensured.

### Introduction

It is well known that each crop demonstrates a certain selectivity and intensity of nutrients assimilation during its growth and development, which undergoes a specific change during the development process of the given

plant. These phenomena are related to the biological characteristics of the plants and environmental conditions.

Nevertheless, the quantitative ratio of the nutrients in the plants' organs is the result of their biological characteristics rather than that of the external factor.

Due to different soil tillage ways and soil improvers application the yield amount and qualitative indicators also change significantly. On the whole, the supply of nutrients to the plants takes place unequally.

The studies related to the dynamics of nitrogen, phosphorus and potassium in the agricultural crops and those of their removal with crop yield are pivotal to increase the application efficiency of mineral and organic fertilizers, as well as different soil tillage methods. Hereby it becomes possible to adjust the doses and application times of fertilizers, as well as to identify the soil cultivation method which ensures the most efficient conditions for the regulation of plant growth, development and nutritional regime.

It has been found out that 35-60 % of dry matters in the plants of winter wheat are accumulated in the first half of the plants growth and development period (before ear formation) in case of traditional soil tillage method (deep plowing), whereas 40-65% - in the second half. The nutrients accumulation dynamics in the winter wheat plants is somehow related to the content of available nutrients in the soil and to the climatic conditions (Avagyan, et al., 1968; Galstyan, 2007).

According to the studies of numerous researchers, the mineral and organic fertilizers and also natural mineral rocks exert a certain effect on the growth and development, as well as on the nutrients dynamics in the winter wheat plants (Melkonyan, et al., 2004; Mineev, et al., 2006; Maksyutova, 2017; Galstyan, 2018; Gharakhanyan, 2022). In order to produce high and stable yields of wheat, is it necessary to apply yield-stimulating macronutrients (Rietra, et al., 2017; Stepień & Wojtkowiak, 2019).

Outstanding Russian scientist-agronomist I.E. Ovinsky (Ovinsky, 1899), showed the redundancy of the plow in soil cultivation. He believed that most soil types contain a huge amount of nutrients and under the conditions of traditional soil cultivation, it is not possible to extract the huge reserves of plant food that are contained in the soil and in the atmosphere. This is accounted for the circumstance that the old soil tillage system not only fails to contribute to the activation of the factors generating plants available nutrients, but also significantly hinders this process.

Different researchers in the RA and abroad have justified that the nutrients output/removal from the winter wheat yield (grain, straw) is mostly related to the yield amount, varietal characteristics, the supply rate of mobile nutrients in the soil and to the climatic conditions (Davtyan & Babayan, 1966; Avagyan, et al., 1968, Mineev, 2004; Galstyan, 2007; Pepó, 2007; Litke, et al., 2018; Yan, et al., 2020).

## Materials and methods

The studies were carried out within 2021-2023 in Fantan administrative area of the Hrazdan consolidated community at the Kotayk region, in rainfed conditions. The field experiments were set up in decalcified common black soils, which are characteristic to that region and the winter cereal crops (mostly 99.2 % winter wheat) are cultivated on those soil types, where the humus content makes 4.9-5.5 %, the medium reaction is close to neutral ( $pH$  6.9-7.2), the content of easy hydrolysable nitrogen per 100 g soil makes 2.94 mg, that of mobile phosphorus – 3.41 mg, and the exchangeable potassium – 37.72 mg.

The research activities aimed to study, for the first time in the region, the effect of different soil tillage methods, application times (autumn, spring) of equal doses of mineral fertilizers and biohumus together with bentonite against the latter's background on the dynamics of nutrients accumulation in the plants of winter wheat and their output/removal via crop yield (grain, straw).

During the two-year investigations the field experiments were set up in three replications; each experimental bed of fertilization in every soil tillage method made 50 m<sup>2</sup>, the experimental options were as follows:

1. Control (without fertilization),
2.  $N_{60}P_{60}K_{60}$ ,
3. Bio-humus 3.5 t/ha,
4.  $N_{60}P_{60}K_{60}$  + bentonite 3 t/ha (in Autumn),
5. Bio-humus 3.5 t/ha + bentonite 3 t/ha (in Autumn),
6.  $N_{60}P_{60}K_{60}$  + bentonite 3 t/ha (in Spring),
7. Bio-humus 3.5 t/ha + bentonite 3 t/ha (in Spring).

The mentioned variants of fertilizers and bentonite have been applied throughout various soil tillage methods, namely in case of no-tillage or zero-tillage method, in case of only loosening or disc harrowing method (10-12 cm) and in case of deep ploughing (22-25 cm).

In all variants, except for the control one, the equal doses of mineral fertilizers and bio-humus were introduced into the soil in Autumn, before sowing (by raking), the doses of bentonite in the options of mineral fertilizers and biohumus (4th and 5th) were applied in autumn, while in the 6th and 7th options it was introduced in spring, again by mixing it with the soil via raking. Sowing, further cultivation and harvesting activities of winter wheat Bezostaya-1 have been implemented in compliance with the agricultural rules common in the region.



In the plant samples taken throughout the bushing, ear formation and maturation phases during vegetation period, the content of N,  $P_2O_5$  and  $K_2O$  have been determined through the generally accepted methods introduced in the methodical guideline on agrochemical analysis published under the editorship of B.A. Yagodin (Yagodin, et al, 1989). The amount of grain and straw yield of winter wheat has been determined during the harvesting period by means of widely used yield calculation method (Rudenko, 1950).

## Results and discussions

The research results have indicated that both in all soil cultivation methods and in the fertilized options set up on those methods, the dynamics of nutrients accumulation in the winter wheat plants took place ununiformly during the vegetation period and more amount of nutrients was accumulated at the bush formation stage. So, if in case of zero-tillage of soil the NPK content in the plants made 2.1, 0.92 and 2.61 %, respectively at the bushing stage, in case of only loosening method - 2.2, 0.96 and 2.54, then during the further stages of wheat growth and development, in case of all soil tillage methods, the migration of nutrients into the plants gradually declined (Table 1). As compared to bush formation stage, in case of no-tillage method, the amounts of nitrogen, phosphorus and potassium decreased in 2.56; 1.77 and 2.46 times, respectively at the ear formation stage, in case of only loosening method - 2.53; 1.67; 2.25 times and in case of traditional ploughing the decrease of those nutrients made 2.41; 1.81 and 2.31, respectively. Similar patterns have been observed in various research works (Avagyan, et al., 1968; Mkrtchyan & Hayrapetyan, 2008; Stepanyan, et al., 2011; Galstyan, 2018).

The data of Table 1 indicate that in case of all soil tillage methods, both in the fertilized and unfertilized options at the ear formation stage the plants demand for potassium was more than that of for nitrogen and phosphorus. Besides, at the mentioned stage the ratio of N,  $P_2O_5$ ,  $K_2O$  in the unfertilized option makes 1, 0.6, 1.29 in case of zero-tillage, while in case of only loosening method it makes 1, 0.69, 1.37, and in traditional tillage it is 1, 0.63, 1.33, respectively.

At the stage of full maturation, in all soil tillage methods, both in fertilized and unfertilized options some redistribution of nutrients occurred in winter wheat plants. Nitrogen (1.94-2.16%) and phosphorus (0.64-0.90%) were accumulated in more amounts in the grains in case of no-tillage method than potassium (0.4-0.49%), whereas in straw potassium was in relatively more amounts than nitrogen and phosphorus.

The same regularities in terms of nutrients redistribution were also observed in the plant grains and straw of fertilized and unfertilized options in case of only loosening and traditional ploughing methods at the phase of full maturation.

The accumulation of nitrogen, phosphorus and potassium in the grain and straw of winter wheat took place at a certain ratio. If in case of unfertilized no-tillage method, this ratio was 1:0.28:0.2 in grain, 1:0.53:2 in straw, then in the fertilized options of the same method in case of mineral fertilizers the ratio of those nutrients in the grain made 1:0.37:0.47, in straw 1:0.65:2.2, meanwhile in case of bio-humus option the ratio in the grain was 1:0.42:0.2, in straw 1:0.74:2.2.

Investigating the issue related to the effect of application times of equal doses of mineral fertilizers and bio-humus with bentonite against their background, as well as that of different soil tillage methods on the nutrients removal/output from the soil together with winter wheat yield (grain and straw), it has been found out that the winter plants have removed various amounts of macronutrients from per hectare soil. The amount of nutrients output was related to the soil cultivation method, crop yield amount, the type of applied fertilizers and to the introduction method of bentonite into the soil (Table 2).

Thus, if in case of no-tillage method 48.2 kg nitrogen, 16.2 kg phosphorus and 30.1 kg potassium was removed from the soil via 19.2 c/ha grain and 36.2 c/ha straw yield per the two-year data, in case of soil tillage through only loosening method 22.4 c/ha grain and 40.0 c/ha straw yield was received and the amount of nitrogen, phosphorus and potassium removed therethrough made 57.2, 19.4 and 34.9 kg, respectively, then in case of traditional ploughing of the soil 47.2 kg nitrogen, 16.4 kg phosphorus and 30.1 kg potassium was removed through the received 19.4 c/ha grain and 36.8 c/ha straw yield. It comes to the point that per the calculation of the removed nutrients from the soil by winter plants related to the soil tillage method, in case of zero soil tillage, 2.51 kg nitrogen, 0.84 kg phosphorus and 1.57 kg potassium was removed from the soil together with 1 centner grain and equal straw yield. Whereas with 1 center grain and equal straw yield of winter plants cultivated through traditional ploughing 2.43 kg nitrogen, 0.85 kg phosphorus and 1.55 kg potassium was removed from the soil and the plants cultivated in conditions of only loosening method removed 2.55 kg nitrogen, 0.87 kg phosphorus and 1.56 kg potassium via the same amount of grain and straw yield.

**Table 1.** The impact of various soil tillage methods, timing of equal mineral fertilizer and biohumus with bentonite applications on the dynamics of macronutrients accumulation in winter wheat plants\*

Options/ Variants	Bushing									Earing/Ear formation								
	No-tillage/zero-tillage			Only loosening			Traditional ploughing			No-tillage			Only loosening			Traditional ploughing		
	N	P <sub>2</sub> O <sub>5</sub>	K <sub>2</sub> O	N	P <sub>2</sub> O <sub>5</sub>	K <sub>2</sub> O	N	P <sub>2</sub> O <sub>5</sub>	K <sub>2</sub> O	N	P <sub>2</sub> O <sub>5</sub>	K <sub>2</sub> O	N	P <sub>2</sub> O <sub>5</sub>	K <sub>2</sub> O	N	P <sub>2</sub> O <sub>5</sub>	K <sub>2</sub> O
Control (without fertilization)	2.10	0.92	2.61	2.20	1.00	2.70	2.00	0.96	2.54	0.82	0.50	1.06	0.87	0.60	1.20	0.83	0.53	1.10
N <sub>60</sub> P <sub>60</sub> K <sub>60</sub>	2.49	1.29	2.90	2.64	1.40	2.94	2.50	1.30	2.86	1.18	0.95	1.85	1.33	1.13	1.93	1.18	0.98	1.90
Bio-humus 3.5 t/ha	2.44	1.30	2.97	2.59	1.38	2.99	2.42	1.28	2.98	1.12	0.80	1.82	1.17	0.92	1.90	1.14	0.83	1.82
N <sub>60</sub> P <sub>60</sub> K <sub>60</sub> + bentonite 3 t/ha (in Autumn)	2.52	1.35	3.19	2.75	1.46	3.31	2.55	1.34	3.09	1.29	0.90	2.00	1.38	1.10	2.18	1.30	0.87	1.98
Bio-humus 3.5 t/ha + bentonite 3t/ha (in Autumn)	2.50	1.32	3.30	2.70	1.40	3.33	2.51	1.29	3.28	1.32	0.87	2.03	1.44	1.04	2.10	1.30	0.91	2.00
N <sub>60</sub> P <sub>60</sub> K <sub>60</sub> + bentonite 3 t/ha (in Spring)	2.46	1.22	2.95	2.63	1.30	3.00	2.40	1.20	2.99	1.20	0.92	1.84	1.35	1.08	1.93	1.19	0.94	1.83
Bio-humus 3.5 t/ha + bentonite 3 t/ha (in Spring)	2.45	1.30	2.94	2.61	1.38	3.12	2.48	1.29	2.96	1.15	0.92	1.85	1.30	1.02	1.98	1.16	0.90	1.88
Options	Full maturation																	
	Grain									Straw								
	No-tillage			Only loosening			Traditional ploughing			No/Zero-tillage			Only loosening			Traditional ploughing		
	N	P <sub>2</sub> O <sub>5</sub>	K <sub>2</sub> O	N	P <sub>2</sub> O <sub>5</sub>	K <sub>2</sub> O	N	P <sub>2</sub> O <sub>5</sub>	K <sub>2</sub> O	N	P <sub>2</sub> O <sub>5</sub>	K <sub>2</sub> O	N	P <sub>2</sub> O <sub>5</sub>	K <sub>2</sub> O	N	P <sub>2</sub> O <sub>5</sub>	K <sub>2</sub> O
Control (without fertilization)	1.94	0.54	0.40	1.98	0.58	0.38	1.90	0.56	0.39	0.30	0.16	0.62	0.32	0.16	0.66	0.28	0.15	0.61
N <sub>60</sub> P <sub>60</sub> K <sub>60</sub>	2.15	0.80	0.46	2.22	0.86	0.49	2.09	0.82	0.47	0.34	0.22	0.76	0.36	0.27	0.82	0.32	0.23	0.77
Bio-humus 3.5 t/ha	2.10	0.89	0.45	2.16	0.91	0.49	2.10	0.89	0.44	0.35	0.26	0.77	0.38	0.26	0.82	0.36	0.25	0.76
N <sub>60</sub> P <sub>60</sub> K <sub>60</sub> + bentonite 3 t/ha (in Autumn)	2.16	0.90	0.49	2.20	0.94	0.51	2.16	0.91	0.50	0.33	0.28	0.85	0.38	0.29	0.90	0.34	0.28	0.84
Bio-humus 3.5 t/ha + bentonite 3t/ha (in Autumn)	2.15	0.87	0.48	2.19	0.94	0.50	2.16	0.89	0.48	0.34	0.26	0.88	0.36	0.26	0.93	0.33	0.28	0.90
N <sub>60</sub> P <sub>60</sub> K <sub>60</sub> + bentonite 3 t/ha (in Spring)	2.12	0.81	0.45	2.19	0.88	0.48	2.07	0.83	0.46	0.31	0.25	0.75	0.37	0.27	0.80	0.31	0.24	0.76
Bio-humus 3.5 t/ha + bentonite 3 t/ha (in Spring)	2.08	0.80	0.46	2.14	0.90	0.49	2.06	0.80	0.45	0.33	0.23	0.76	0.36	0.23	0.81	0.32	0.24	0.75

\*Composed by the authors.

**Table 2.** The effect of different soil tillage methods, application times of equal doses of mineral fertilizers and biohumus with bentonite against their background on the nutrients output/removal via winter wheat crop yield (grain, straw)\*

Soil tillage methods	Options/variants	Yield, c/ha		Nutrients output, kg/ha						Total output, kg/ha		
		Grain	Straw	Grain			Straw			N	P <sub>2</sub> O <sub>5</sub>	K <sub>2</sub> O
				N	P <sub>2</sub> O <sub>5</sub>	K <sub>2</sub> O	N	P <sub>2</sub> O <sub>5</sub>	K <sub>2</sub> O			
No-tillage (0-tillage)	Control (without fertilization)	19.2	36.2	37.3	10.4	7.7	10.9	5.8	22.4	48.2	16.2	30.1
	<i>N<sub>60</sub>P<sub>60</sub>K<sub>60</sub></i>	27.0	54.0	58.1	21.6	12.4	18.4	11.9	41.0	76.5	33.5	53.4
	Bio-humus 3.5 t/ha	28.4	56.0	59.6	25.3	12.8	19.6	14.6	43.0	79.2	39.9	56.4
	<i>N<sub>60</sub>P<sub>60</sub>K<sub>60</sub></i> + bentonite 3 t/ha (in Autumn)	38.2	74.8	82.5	34.4	18.7	24.7	20.9	63.6	107.2	55.3	82.3
	Bio-humus 3.5 t/ha + bentonite 3 t/ha (in Autumn)	41.8	80.0	89.9	36.4	20.1	27.2	20.8	70.4	117.1	57.2	90.5
	<i>N<sub>60</sub>P<sub>60</sub>K<sub>60</sub></i> + bentonite 3 t/ha (in Spring)	28.0	55.2	59.4	22.7	12.6	17.1	13.8	41.4	76.5	36.5	54.0
	Bio-humus 3.5 t/ha + bentonite 3 t/ha (in Spring)	29.0	57.0	60.3	23.2	13.3	18.8	13.1	43.3	79.1	36.3	56.6
Only loosening	Control (without fertilization)	22.4	40.0	44.4	13.0	8.5	12.8	6.4	26.4	57.2	19.4	34.9
	<i>N<sub>60</sub>P<sub>60</sub>K<sub>60</sub></i>	31.0	59.0	68.8	26.7	15.2	21.2	14.2	48.4	90.0	40.9	63.6
	Bio-humus 3.5 t/ha	30.8	59.0	66.5	28.0	15.1	22.4	15.3	48.4	88.9	43.3	63.5
	<i>N<sub>60</sub>P<sub>60</sub>K<sub>60</sub></i> + bentonite 3 t/ha (in Autumn)	48.8	89.0	107.4	45.9	24.9	33.8	25.8	80.1	141.2	71.7	106.0
	Bio-humus 3.5 t/ha + bentonite 3 t/ha (in Autumn)	52.0	96.0	113.9	48.9	26.0	34.6	25.0	89.3	148.9	73.9	115.3
	<i>N<sub>60</sub>P<sub>60</sub>K<sub>60</sub></i> + bentonite 3 t/ha (in Spring)	36.4	70.8	79.7	32.0	17.5	26.2	19.1	56.6	105.9	51.1	74.1
	Bio-humus 3.5 t/ha + bentonite 3 t/ha (in Spring)	36.8	71.0	78.8	33.1	18.0	25.6	16.3	57.5	104.4	49.4	75.5
Traditional ploughing	Control (without fertilization)	19.4	36.8	36.9	10.9	7.6	10.3	5.5	22.5	47.2	15.4	30.1
	<i>N<sub>60</sub>P<sub>60</sub>K<sub>60</sub></i>	28.0	55.8	58.5	23.0	13.2	17.9	12.8	43.0	76.4	35.8	56.2
	Bio-humus 3.5 t/ha	28.2	56.0	59.2	25.1	12.4	20.2	14.0	42.6	79.4	39.1	55.0
	<i>N<sub>60</sub>P<sub>60</sub>K<sub>60</sub></i> + bentonite 3 t/ha (in Autumn)	43.6	81.0	94.2	39.7	21.8	27.5	22.7	68.0	121.7	62.4	89.8
	Bio-humus 3.5 t/ha + bentonite 3 t/ha (in Autumn)	45.0	84.0	97.2	40.1	21.6	27.7	23.5	75.6	124.9	63.6	97.2
	<i>N<sub>60</sub>P<sub>60</sub>K<sub>60</sub></i> + bentonite 3 t/ha (in Spring)	32.1	60.0	66.5	26.1	14.8	18.6	14.4	45.6	85.1	40.5	60.4
	Bio-humus 3.5 t/ha + bentonite 3 t/ha (in Spring)	31.9	61.0	65.7	25.5	14.4	19.5	14.6	45.8	85.2	40.1	60.2

\*Composed by the authors.

Analysing the behaviour of winter wheat grown under different soil tillage methods regarding the nutrients absorption, as well as the yield amount of grain and straw, it becomes clear that the plants have put out from the soil almost equal amount of nitrogen, phosphorus and potassium through 1 centner wheat and the same amount of straw, nevertheless, related to soil cultivation methods different amounts of grain and straw yield have been developed. This circumstance is mainly related to the fact, that soil tillage by means of only loosening method, has created more favorable conditions in terms of air and humidity regimes for the plants growth and yield development ensuring 22.4 c/ha grain yield, whereas in case of no-tillage and traditional ploughing methods the grain yield has made 19.2 c/ha and 19.4 c/ha, respectively.

Meanwhile the data of Table 2 indicate, that the equal amounts of mineral fertilizers and biohumus with bentonite applied in different time periods against their background throughout different soil tillage methods, have considerably affected the development of winter wheat grain and straw yield, as well as the amount of nutrients removal/output via the crop yield.

Under the effect of equal doses of mineral fertilizers and bio-humus and application times of bentonite (autumn and spring) against their background the plants have removed almost twice and thrice more nutrients via the yield in case of all soil tillage methods, than the grain and straw produced in unfertilized options in case of appropriate soil tillage method. The phenomenon of chemotaxis was probably observed here, i.e. plants in nutrient-rich soil environment absorbed available nutrients faster and in more amounts than from a relatively poor environment (in unfertilized options). The calculations have shown that the same doses of fertilizers and bio-humus have equally affected both the nutrients accumulation dynamics and their removal/output through 1 c wheat yield (grain, straw).

## Conclusion

Summing up the results of the study on the effect of different soil tillage methods, equal doses of mineral fertilizers and bio-humus with bentonite applied at different time periods against the latter's background on the dynamics of macronutrients accumulation in winter wheat plants and on their output rate via crop yield the following conclusions have been drawn:

1. In the winter wheat plants of Bezostaya 1 variety, irrespective of soil tillage methods and the doses and application ways of soil improvers, the major part of

nutrients are accumulated during the first stages of plants growth and development. The intensity of nutrients accumulation slows down in further stages. From the bushing stage up to the ear formation one the winter plants demand is more for nitrogen and potassium than for phosphorus, while from ear formation to the maturation phase the need for potassium grows up.

2. The equal doses of mineral fertilizers and bio-humus have uniformly affected the dynamics of nutrients accumulation and their removal/output via yield.

3. The nutrients outcast from the soil and their output with the crop yield is related to the soil tillage method, the amount of grain and straw yield, the doses of fertilizers and their application times.

4. For the development of 1 c grain and equivalent straw yield in conditions of zero soil tillage, only loosening and traditional ploughing methods, the winter wheat plants absorb NPK from the soil 2.51, 0.84 and 1.57 kg; 2.43, 0.85 and 1.55 kg, and 2.55, 0.87 and 1.56 kg, respectively. i.e., the soil tillage method has no significant effect on the nutrients removal/output rate.

5. The analysis of the data on the effect of different soil tillage methods for the development of grain and straw yield in unit amount under rainfed conditions, as well as that of applied fertilizers and bentonite has been conducted. In order to ensure high and sustainable yield of winter wheat plants cultivated under the mentioned conditions, it is necessary to cultivate the soil through only loosening method (loosening the soil with the depth of 10-12 cm), while when organizing fertilization activities the natural mineral rock bentonite (3 t/ha) on the background of either equal doses of mineral fertilizers ( $N_{60}P_{60}K_{60}$ ) or bio-humus (3.5 t/ha) should be introduced into the soil in autumn, as a result of which the soil air, nutritional and humidity regimes improve, favorable conditions are created for the regular growth and development of the plants and per two-year average data 48.8-52 c/ha grain and 89.0-96.0 c/ha straw yield is ensured.

## References

1. Avagyan, N.O., Arazyan, S.M., Krnatyan, T.S., Abazyan, S.P., Mirakyan, Sh.Kh, Hakobyan, S.A. (1968). Dynamics of nutrients accumulation and their removal through the cereal crops. Proceedings of the Research Institute of Soil Science and Agrochemistry of the Ministry of Agriculture of the Armenian SSR. Issue 4, - pp. 509-526 (in Russian).

2. Davtyan, G.S., Babayan, G.B. (1966). Agrochemical characteristics of the soil cover of the Armenian SSR. Yerevan, USSR SA Publishing House, - 131 p. (in Russian).
3. Galstyan, M.H. (2007). Fertilization efficiency of winter wheat and potatoes under the conditions of the Sevan basin, Yerevan, Limush, - 156 p. (in Armenian).
4. Galstyan, M.H. (2018). Environmental biotechnologies. A textbook for students of the RA universities, Yerevan, "Meknark", - 300 p. (in Armenian).
5. Gharakhanyan, K.A. (2022). The effect of different soil cultivation methods and soil improvers on winter-hardiness and yield structural elements of winter wheat. Biological Journal of RA NAS, 74, 4, - pp. 29-38 (in Armenian).
6. Litke, L., Gaile, Z., & Ruža, A. (2018). Effect of nitrogen fertilization on winter wheat yield and yield quality <http://dx.doi.org/10.22616/rrd.23.2017.049>.
7. Maksyutova, O. (2017). Functional Minerals. Chemical Journal. World Market, - pp. 20-25 (in Russian).
8. Melkonyan, K.G., Ghazaryan, H.Gh., Manukyan, R.R. (2004). The current ecological state of agricultural lands, land use level, management improvement and ways of efficiency enhancement in the Republic of Armenia. Yerevan, Scientific Center of Soil Science, Agrochemistry and Melioration, - 54 p. (in Armenian).
9. Mineev, V.G. (2004). Agrochemistry, M. "Kolos", - 719 p. (in Russian).
10. Mineev, V.G., Gomonova, N.F., Amelyanchik, O.A. (2006). Changes in the properties of sod-podzolic soil with long-term complex use of agrochemicals // Annals of Agrarian Science, Tbilisi, - № 4, - pp. 17-21.
11. Mkrtchyan, R.S., Hayrapetyan, F.P. (2008). Nature calendar of Armenia. Seasonal Rhythmicity of Nature in Armenia (second revised edition) – Yerevan, YSU Publishing House, - 300 p. (in Armenian).
12. Ovsinsky, I.E. (1899). New system of agriculture, Kyiv, - 138 p. (in Russian).
13. Pepó, P. (2007). The role of fertilization and genotype in sustainable winter wheat (*Triticum aestivum* L.) production. Cereal Research Communications, 35, 917-920 <http://dx.doi.org/10.1556/crc.35.2007.2.188>.
14. Rietra, R.P., Heinen, M., Dimkpa, C.O., Bindraban, P.S. (2017). Effects of nutrient antagonism and synergism on yield and fertilizer use efficiency. Communications in soil science and plant analysis, 48(16), - pp. 1895-1920 <http://dx.doi.org/10.1080/00103624.2017.1407429>.
15. Rudenko, A.I. (1950). Determination of development phases of agricultural crops. M., Moscow General Nature Study, - 150 p. (in Russian).
16. Stepanyan, V.E., Galstyan, M.A., Azaryan, S.Kh., Khanbabayan, M.V., Avagyan, A.A. (2011). Ecological-geological and socio-economic foundations for assessing natural-technogenic negative changes in the environment of urbanized territories of Armenia. Yerevan, Asoghik, - 420 p. (in Armenian).
17. Stepien, A., Wojtkowiak, K. (2019). Evaluation of the effect of different levels of nitrogen and manganese fertiliser on the yield, macronutrient content and technological properties of winter wheat. Journal of Elementology, 24(2) <http://dx.doi.org/10.5601/jelem.2018.23.4.1706>.
18. Yagodin, B.A., Smirnov, P.M., Peterburgsky, A.V., Kudin, V.V., Sliptsik, A.V., Kuzukin, A.N., Sablin, S.M. (1989). Agrochemistry (edited by B.A. Yagodin), 2<sup>nd</sup> ed., M. Agropromizdat, - 639 p. (in Russian).
19. Yan, S., Wu, Y., Fan, J., Zhang, F., Zheng, J., Qiang, S., Wu, L. (2020). Dynamic change and accumulation of grain macronutrient (N, P and K) concentrations in winter wheat under different drip fertigation regimes. Field crops research, - p. 250 <http://dx.doi.org/10.1016/j.fcr.2020.107767>.

---

Accepted on 16.10.2023

Reviewed on 04.12.2023





UDC 635.64:631.24

## Study of Growth, Yield, and Yield Quality Indicators of Tomato Hybrids in Hydroponic Systems under Greenhouse Conditions

A.M. Tadevosyan, N.A. Gasparyan, H.Z. Terteryan

Armenian National Agrarian University

[alinatadevosyan1972@mail.ru](mailto:alinatadevosyan1972@mail.ru), [naira\\_job@yahoo.com](mailto:naira_job@yahoo.com), [hasmik\\_terteryan1959@mail.ru](mailto:hasmik_terteryan1959@mail.ru)

### ARTICLE INFO

#### Keywords:

tomato,  
hydroponic system,  
greenhouse,  
hybrid tomato,  
yield

### ABSTRACT

The main goal of the research was to study greenhouse tomato hybrids under hydroponic greenhouse conditions and to enhance the agro-economic properties of tomato hybrids, offering farmers the hybrid that ensures high efficiency of tomato cultivation under hydroponic greenhouse conditions. During the vegetation period, phenological observations, biometric measurements, and crop counting were performed. Producing and selling vegetables in the local market is the primary activity of greenhouses and tomatoes occupy a significant place in vegetable production. In recent years, various varieties and hybrids have been imported into Armenia, most without testing. Tomato cultivation in greenhouses occupies a leading place in Armenia. The greenhouse tomato hybrids Merlis, Plumola, and Endeavor were researched.

### Introduction

The common tomato, *Lycopersicon esculentum* Mill., is the most widespread species belonging to the genus *Lycopersicon* Tourn of the Solanaceae family (Edelshtein, 1962; Ananyan, et al., 1965; Zhukovsky, 1971; Zhuchenko, 1973; Matveev, Rubtsov, 1985; Akhatov, 2010, Chernysheva and Kolpakov, 2022). All tomato cultivars currently cultivated belong to *Lycopersicon esculentum* Mill., the biological species, which in turn is subdivided into three subspecies:

1. subsp. *spontaneum* Brezn – is a wild subspecies, which is divided into two other species: currant-like (var. *pimpinellifolium*) and raceme-like (var. *racemigerum*).

2. subsp. *subspontaneum* Brezn – is a semi-cultivated subspecies, which is divided into 5 other species: cherry-like (var. *cerasiforme*), pear-like (var. *pyriforme*), plum-like (var. *pruniforme*), elongated (var. *elongatum*), multi-stemmed (var. *succenturiatum*).

3. subsp. *cultum* Brezn – is a cultural subspecies, which is divided into the following varieties: common (var. *vulgare*), erect (var. *vulgare*), and large-leaved (var. *grandifolium*) (Zhuchenko, 1973; Akhatov, 2010).

Tomato subsp. *cultum* includes all cultivated varieties, which are divided into three groups according to the shape of the bush, the dynamics of the formation of leaves, flower clusters, and branches (Melikyan, 2005).

In greenhouses, when cultivated on vertical wires, the stem length of some varieties can reach up to 10 m or more. For example, in 2000 in Great Britain, vegetable growers grew tomato plants with a stem length of 19.8 m in greenhouses (Rubtsov, 2003; Melikyan, 2005; Akhatov, 2010). The high yield of tomato varieties and hybrids is not the only thing that matters, but the amount of biologically active substances contained in the fruits are also important. The quality and taste of the fruits are indicators of the fruits' nutritional value (Dilanyan, 2003; Kondratyev and Kandoba, 2007; Helmut, 2000). Tomatoes are rich in nutrients. Besides having high taste properties, fruits contain substances essential to human health. These substances include vitamins *A*, *B*, *C*, and *PP*, sugars, organic acids - citric acid, minerals - *Ca*, *Na*, *Mg*, *Fe*, etc. (Ayrapetova, 2000; Zurabyan, et al., 2003; Dilanyan, 2003; Kondrat'eva and Kondoba, 2007).

During 2018-2019, the Merlis hybrid was tested in a greenhouse environment of the Venlo type in the Lipetsk region of the Russian Federation (Bocharova, et al., 2020). A comparison was made between Maxesa and Merlis hybrids. Maxesa hybrid yield indicators were 68.3 kg m<sup>2</sup> and Merlis hybrid yield indicators were 66.9 kg m<sup>2</sup>. The Endeavor (Pic. 3) hybrid was also tested on various grafters in the Leningrad region of the Russian Federation in 2017-2018 (Puts and Snezhkov, 2021).

## Materials and methods

The studies were carried out in 2021-2023, in the hydroponic greenhouse of Armenian National Agrarian University. The experiment includes two production phases. The

object of the research was the tomato hybrids Merlis, Plumola, and Endeavor, which have not been compared under the given greenhouse conditions. Experiments were set up with 3 versions, and 4 replications. Several tomato hybrids were tested and the best were selected for recommendation to greenhouse farmers.

Planting density is determined by solar radiation, and the hybrid's growth (Asatryan, 2021). Planting density was 3.2 plants/m<sup>2</sup>. During the growing season, the culture was carried out in a hydroponic greenhouse conditions according to the accepted culture protocol.

The following cultural activities were carried out: watering, nutrition, fixing stems to wires, pruning, removing leaves, lowering plants, pollination, and harvesting. Phenological observations, biometric measurements, and crop counting were conducted during the vegetation period. Following accepted agro-rules, climatic and nutritional regimes, as well as agro-technical measures, were provided for normal plant growth and development (Asatryan, 2021).

## Results and discussions

The vegetation period is one of the most essential biological characteristics of the plants (Belik, 2000; Fatyanov, 2005; Torikov and Sychev, 2022). During the studies conducted in the vegetation period, phenological observations were made visually, and the beginning of regrowth, emergence of secondary and third stems, bud formation on the first and second flower clusters, the beginning of flowering, fruit formation, and fruit development stages were noted per the maturation times of the individual variants (Table 1).

**Table 1.** Vegetation period of tomato hybrids\*

Tomato hybrids	Time to move to the greenhouse	Beginning of regrowth	Emergence of secondary stems	Emergence of third stems	The first inflorescence				The last inflorescence				Vegetation period (days)
					Bud formation	Beginning of flowering	Fruit formation	Fruit ripening	Bud formation	Beginning of flowering	Fruit formation	Fruit ripening	
Merlis	15.02	21.02	01.03	11.03	16.03	21.03	26.03	10.05	21.08	26.08	02.09	08.09	203
Endeavor	15.02	23.02	08.03	15.03	20.03	23.03	31.03	17.05	26.08	30.08	04.09	10.09	207
Prumola	15.02	22.02	04.03	13.03	18.03	22.03	29.03	14.05	23.08	28.08	03.09	09.09	206

\*Composed by the authors.

**Table 2.** Weekly average growth of tomato hybrids\*

Tomato hybrids	Weekly average growth (cm)	Average weekly growth			
		Number of leaves	Number of inflorescences	Number of flowers	Number of fruits per cluster
Merlis	17	3	1	7	5
Endeavor	16	3	1	6	4
Prumola	13	3	1	5	3

**Table 3.** Characteristics of the tested tomato hybrids\*

Tomato hybrids	Fruit diameter (cm)	Average fruit mass (g)	Locule number
Merlis	21.4	130.2	3
Endeavor	19.9	127.8	3
Prumola	18.2	88.4	3

\*Composed by the authors.

The studies have indicated that different hybrids of tomato plants have a slight difference in their growth and development stages with 3-4 days of variation. However, there was no significant difference between hybrids in terms of their growth, development, and vegetation period. The vegetation period was ranged from 203 to 207 days. In addition to phenological observations, biometric measurements were also conducted to study the morphological characteristics of the tomato plants (Table 2).

According to the data, the Merlis hybrid recorded the highest average weekly growth, 17 cm, whereas Plumola hybrids had the lowest height, 13 cm. Hybrids had the same number of leaves: 3 leaves appeared per week. The number of flowers in the investigated tomato hybrids varied from 5 to 7, the Merlis had the most.

Plant growth and quality indicators of yield should also be monitored during cultivation. There are clear requirements for export, which are internationally defined, according to which the quality indicators of the crop must meet the specified standards. According to the interstate standard 2018 on the requirements for the quality of tomatoes for fresh consumption, the quality of the tomato crop obtained as a result of the test was in compliance with the standard.

Merlis hybrids (Pic. 1) had the largest average fruit mass and fruit diameter, 130.2 g and 21.4 g, and Plumola (Pic. 2) was 88.4 g and 18.2 cm (Table 3).

Regarding fruit diameter and weight, Endeavor ranks between Merlis and Plumola hybrids. "Standard Dialog" LLC also conducted a chemical analysis of the harvested material (Table 4).

**Picture 1.** Cross section of Merlis hybrid.**Picture 2.** Transverse section of Plumola hybrid.**Picture 3.** Cross-section of Endeavor hybrid.



**Table 4.** Results of laboratory tests of fruits in experimented hybrids\*

N	Index	Unit of measurement	Index value		Conclusion according to the results
			According to the normative documents	Results	
1.	Lead	Mg/kg	<0.5	<0.001	appropriate
	Arsenic	Mg/kg	<0.2	<0.001	
	Cadmium	Mg/kg	<0.03	<0.0001	
	Mercury	Mg/kg	<0.02	<0.0001	
2.	Lead	Mg/kg	<0.5	<0.001	appropriate
	Arsenic	Mg/kg	<0.2	<0.001	
	Cadmium	Mg/kg	<0.03	<0.0001	
	Mercury	Mg/kg	<0.02	<0.0001	
3.	Lead	Mg/kg	<0.5	<0.001	appropriate
	Arsenic	Mg/kg	<0.2	<0.001	
	Cadmium	Mg/kg	<0.03	<0.0001	
	Mercury	Mg/kg	<0.02	<0.0001	
4.	Nitrates	Mg/kg	<150	62.5	appropriate
	Patulin	Mg/kg	<0.05	<0.0001	
	Dry matter content in the liquid phase	%	-	4.0	
5.	Nitrates	Mg/kg	<150	58.61	appropriate
	Patulin	Mg/kg	<0.05	<0.0001	
	Dry matter content in the liquid phase	%	-	4.3	
6.	Nitrates	Mg/kg	<150	49.12	appropriate
	Patulin	Mg/kg	<0.05	<0.0001	
	Dry matter content in the liquid phase	%	-	5.0	

**Table 5.** The yield of tomato hybrids\*

Hybrids	Yield		The difference according to the mean (6.9)	
	Kg/plant	Kg/m <sup>2</sup>	Kg/plant	%
Merlis	7.3	23.3	0.4	5.8
Endeavor	6.9	22	0.0	0.0
Prumola	6.4	20.4	-0.5	-7.2

\*Composed by the authors.

**Figure.** Yield of tomato hybrids, kg/plant (composed by the authors).

Table data show that the obtained fruits are also ecologically safe. It is important to harvest tomatoes on time and sort the fruits as soon as possible after harvesting. Fruits are stored in small boxes with their stalks facing up. A high yield is the ultimate goal of developing any crop variety or hybrid.

The yield indicator was also determined by recording the yield per unit area (1 m<sup>2</sup>) (Table 5, Figure).

As a result of our experiment, the Merlis hybrid has recorded the highest yield: 23.3 kg/m<sup>2</sup>, Endeavor had 22 kg/m<sup>2</sup>, and the Plumola hybrid had the lowest yield: 20.4 kg/m<sup>2</sup>.

Regarding the mathematical analysis of the yield data, it is worth mentioning that the error of the experiment is within the permissible limits, and differences in yield of individual hybrids were compared with the average index of the three versions, 6.9 kg/plant, according to which there are no significant differences between them. However, the index of the first version increases, whereas the third version decreases.

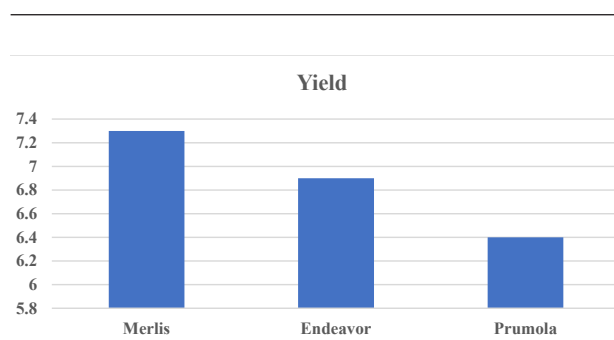
It is also important to note that no crop diseases were observed during the vegetation period; greenhouse whitefly (*Trialeurodes vaporariorum*) and tomato moth (*Tuta Absoluta*) were observed as pests, which were controlled with appropriate plant protection products.

## Conclusion

In contrast to the other tested varieties, the Merlis hybrid had a shorter vegetation period of 203 days, 3-4 days shorter than the other varieties. Another notable feature of the Merlis hybrid was the number of fruits formed on one bush, which amounted to 6, against those of other hybrids with 1-3 fruits. Merlis hybrid showed the highest weekly growth rate, 23.5 %.

Based on the yield data from the unit area (1 m<sup>2</sup>), the Merlis hybrid has again obtained a yield of 23.3 kg/m<sup>2</sup>, surpassing the yield of the other tested hybrids by 1.3-2.9 kg. According to the research findings, Merlis is preferred over other hybrids for cultivation in hydroponic conditions. Anyhow, hydroponic cultivation is also effective with Endeavor and Plumola hybrids.

## References

1. Akhatov, A.K. (2010). *The World of Tomatoes from the View of a Phytopathologist*. – Moscow, publisher “KMK”, - 288 p. (in Russian).
2. Ananyan, A.A., Yeghiazaryan, A.G., Grigorya, A.A. (1965). *Vegetable crops of Armenia*. - Yerevan, “State Publishing House of Armenia”, -175 p. (in Armenian).
3. Asatryan, A. (2021). *Features of tomato, cucumber, and strawberry cultivation in greenhouses*. Farmer’s Guide, Yerevan (in Armenian).
4. Ayrapetova, S.A. (2000). *The selection of tomato with the usage of the genome of wild and semicultured species. The main issues of selection, seed production and cultivation technology vegetable cultures in XXI century*, Yerevan, - 25 p. (in Russian).
5. Bocharova, M.A., Terekhova, V.I., Marcheva, M.M. (2020). *Comparative assessment of valuable characteristics of F1 hybrids of tomatoes on the basis of “Ovoschi Chernozemya” LTD enterprise, in transitional rotation. A collection of articles of pan-Russian scientific conference with international participation Plant Production and Meadow farming, Moscow Agricultural Academy named after Timiryazev*, - pp. 518-523 <http://dx.doi.org/10.37925/0039-713x-2020-4-7-9> (in Russian).
6. Belik, V.F. (2000). *Squash and other pumpkin family plants, second edition, republished*, Moscow, Kolos, - p. 48 (in Russian).
7. Chernysheva, N.N., Kolpakov, N.A. (2024). *Horticulture Practicum, Tutorial*, Moscow, - 288 p. (in Russian).
8. Dilanyan, V.T. (2003). *Combined ability determinant lines based on the quantity of dry material in the fruits of tomato*, *Agronauka*, - № 9-10, - pp. 413-416 (in Armenian).
9. Edelshtein, V.I. (1962). *Horticulture, the 3rd edition, published*, Moscow, SELkhozgiz, - 440 p. (in Russian).
10. Fatyanov, V.I. (2005). *Melons, Pumpkins, Squashes, Patissons*. Moscow, - 32 p. (in Russian).
11. Helmut, K. (2000). *Horticulture*, Moscow, Kolos, - p. 572 (in Russian).
12. Interstate standard, GOST 34298 (2018). *Fresh tomatoes, Technical specifications, UNECE STANDARD FFV-36:2018, Concerning the marketing and commercial quality control of tomatoes, MOD*, Moscow, Satndardinform, -15 p.
13. Kondratyeva, I.U, Kandoba, E.E. (2007). *The content of dry material in the fruits of tomato determines*

- their taste, Potato, and vegetables, - № 6, - pp. 23-24 (in Russian).
14. Matveev, V.P., Rubtsov, M.I. (1985). Horticulture, the 3rd edition, Agropromizdat, - 431 p. (in Russian).
15. Melikyan, A.Sh. (2005). Vegetable cultivation, Yerevan (in Armenian).
16. Puts, N.M., Snezhkov, N.A. (2021). Innovative agricultural techniques for growing tomatoes in winter greenhouses, Izvestiya of Sankt-Peterburg Agricultural University, N 1 (62), - pp. 36-42 (in Russian).
17. Torikov, V.E., Sychev, S.M., Horticulture, Tutorial, Sank-Peterburg, Lan, 2022, -124 p. (in Russian).
18. Zhuchenko, A.A. (1973). Tomato genetics, Kishinyov, Shtiinca, - 664 p. (in Russian).
19. Zhukovsky, P.M. (1971). Cultured plants and their kinsmen, Leningrad, Kolos, -752 p. (in Russian).
20. Zurabyan, V.I, Mkoyan, R.O. (2003). The effect of tomato selection on the quality of fruits, Izvestiya, Armenian Agricultural Academy, - № 2, - pp. 15-16 (in Armenian).

---

*Accepted on 25.09.2023*

*Reviewed on 07.11.2023*



Journal homepage: [anau.am/scientific-journal](http://anau.am/scientific-journal)

doi: [10.52276/25792822-2023.4-353](https://doi.org/10.52276/25792822-2023.4-353)

UDC 619:616.98:579.841.936

## Knowledge, Attitudes, Practices (KAP) of Brucellosis in Occupationally Exposed Groups in Armenia

H.M. Danelyan, P.G. Tumanyan, A.A. Hovhannisyan

Reference Laboratory for Especially Dangerous Pathogens, RVSPCLS SNCO, RA

Kh.V. Sargsyan

Scientific Centre for Risk Assessment and Analysis in Food Safety Area

[hrantdanelyanedp@gmail.com](mailto:hrantdanelyanedp@gmail.com), [tumanyanp@gmail.com](mailto:tumanyanp@gmail.com), [hov-ashi@yandex.ru](mailto:hov-ashi@yandex.ru), [khachikvsargsyan@mail.ru](mailto:khachikvsargsyan@mail.ru)

### ARTICLE INFO

**Keywords:**

*brucellosis,  
knowledge of brucellosis in the  
occupational group,  
one health,  
risk factors,  
zoonosis*

### ABSTRACT

Brucellosis, a bacterial disease caused by the genus *Brucella*, is a zoonotic and occupational disease. A high risk of infection with *Brucella* is associated with the workplace. Infection may occur by inhalation, conjunctival or skin contamination, accidental injury with a syringe, or exposure in a slaughterhouse or food processing facility. This study delves into Brucellosis, a zoonotic bacterial disease caused by *Brucella*, focusing on occupational exposure among slaughterhouse workers and food processors in Armenia. The research assesses the knowledge, attitudes, and practices of 306 participants, including 18 slaughterhouse workers and 288 food processors (76 meat and 212 milk employees). Despite universal awareness (100 %) of Brucellosis risk, the study uncovers potential shortcomings in workplace practices, notably in the use of personal protective equipment (PPE), as 43.9 % of respondents wash their working clothes at home. The findings underscore the need for ongoing education and remediation efforts to enhance safety measures and also emphasize the imperative of addressing these issues within at-risk groups in Armenia.

### Introduction

Brucellosis is the most common bacterial zoonotic disease worldwide, with global distribution and thousands of new cases among people (Rubach, et al., 2013). Brucellosis is transmitted to humans from infected animals (usually livestock and dogs), either through direct inoculation or

consumption of contaminated food and milk (Galinska and Zagorski, 2013). *Brucella* is an intracellular, small Gram-negative aerobic bacterium, that is readily killed by boiling or pasteurization. Thus food-borne exposure is normally limited to persons consuming unpasteurized milk and dairy products (Corbel and Banai, 2005). However, brucellosis

is also considered primarily an occupational hazard affecting those working with infected animals or their tissues farmers, livestock breeders, veterinarians, abattoir workers, and other high-risk groups (Ning, et al., 2013). These occupational risks include exposure and contact with an entry of the bacteria through cuts and abrasions in the skin. Brucellosis is also a hazard affecting laboratory workers handling specimens containing *Brucella* species, as the pathogen is readily aerosolized and has a low infective dose (Yagupsky and Baron, 2005).

The incidence of brucellosis in humans is declining in many countries due to systematic efforts to control the disease in animals, particularly in developed nations (Detailed Countries Disease Incidence, 2014), however, brucellosis is widespread among agricultural animals in Armenia; which represents a significant threat to public health.

The emergence and spread of this disease are driven by many factors, including expanded livestock breeding and urbanization, increased animal migration, and inadequate sanitary and hygiene arrangements in livestock breeding and food processing (Chen, et al., 2014). According to data from the Ministry of Health (MOH) of the Republic of Armenia, the number of first-time human brucellosis cases has increased annually since 2004 (personal communications). The disease occurs as small outbreaks (worldwide it is commonly known to be caused by the consumption of raw milk) and isolated cases throughout the country and is most prevalent in the provinces (Dhanashekar, et al., 2012).

Brucellosis-related information is specific for high-risk groups. In terms of economic importance, the eradication of brucellosis in animals is vital. In addition to economic damage, brucellosis causes infertility, production losses, and mandatory slaughter of infected animals, and it also increases health care costs, treatment costs, and strains on the entire healthcare system (Dragon, 2004).

The presence of *Brucella* is routinely detected in large and small ruminants in almost all Armenian provinces. The current epidemiology of human brucellosis in Armenia is attributed to an increase in the number of patients with brucellosis with an unidentified source of infection. There is a high proportion of young people of working age who are among those affected by brucellosis. There is also an increase in infected individuals who are not in the classically known 'high-risk' occupational groups. Despite the high level of primary registration of patients with brucellosis, it can be assumed that the true situation with morbidity is

much more strained because it has been shown that rural residents do not readily seek medical aid from medical and preventive facilities. Testing asymptomatic individuals in high-risk areas is the only reliable way to obtain accurate human brucellosis statistics in endemic countries like Armenia. Human brucellosis tests are not very sensitive and do not detect chronic cases of the disease (De Santis, et al., 2011).

Considering the current situation in Armenia, there is a distinct need for a well-defined program for brucellosis control and prevention among large and small ruminants in Armenia. Some measures, particularly laboratory testing and sanitary slaughtering, are already being implemented. Successful prevention and control programs for brucellosis are carried out by the close cooperation between veterinary, medical, and sanitary services.

Clinical manifestations of brucellosis in humans differ from those in animals. The incubation period for *Brucella* species is highly variable, but it usually ranges from five to sixty days. Symptoms can not generally be differentiated by species though the specific manifestations of the high (*B. melitensis*, *B. abortus* and *B. suis*) and low-frequency pathogens (*B. canis*, *B. pinnipedialis*, *B. ceti*, and *B. inopinata*) causing human brucellosis (Garcia and Isenberg, 2007).

The symptomology between *B. melitensis*, *B. abortus*, and *B. suis* is largely indistinguishable. Clinical presentations are usually divided into acute, sub-acute (or undulant), and chronic brucellosis (depending on the amount of time the patient has had symptoms) for *B. melitensis* infections. This is less useful for patients with *B. abortus* or *B. suis* infections, as the chronic or recurring forms are uncommon (Zhen, et al., 2013).

Brucellosis diagnosis is challenging because of disease presentation variability. The situation becomes more complicated in cases where, along with brucellosis, there are other pathological processes, that affect the manifestation of clinical signs (Garcia and Isenberg, 2007).

Understanding the level of knowledge, attitudes, and practices of respondents, carefully designed awareness, training, and capacity building programs can be designed to achieve better outcomes. The current study aimed to assess the extent of knowledge and understanding of brucellosis in occupationally high-risk groups across the entire country of Armenia to identify practices on the job site that might pose a risk for humans contracting brucellosis.

## Materials and Methods

### Questionnaire development

The survey included three-parts knowledge, attitude, and practice (KAP). All of the information was collected using the questionnaire, which was designed by a group of specialists and consists of the following sections: demographic data, knowledge, attitude, and practice. The questionnaire consisted of over 200 questions (parsed based on occupation), related to the causative agents of brucellosis, routes of transmission, source of infection, clinical features, diagnostics, and treatment questions related to attitude and practice regarding human brucellosis and the diagnosis and treatment of disease from a clinical point of view. The questionnaire employed a quantitative and qualitative approach and contained closed-ended and open-ended questions. This survey was coupled with a public outreach campaign with training materials based on the safe handling of animals suspected of carrying brucellosis and included proper practices for handling animal products suspected of disease.

### Study area, design, and selection of participants

Between July and October 2021, a cross-sectional study using an interview-based survey was conducted among high-risk groups. Armenia is subdivided into eleven administrative divisions. Of these, ten are Marzes. This cross-sectional study was carried out in all Marzes across Armenia and Yerevan; Figure 1 shows the map of Armenia with each of the provinces identified (Aragatsotn, Ararat, Armavir, Gegharkunik, Kotayk, Lori, Shirak, Syunik, Tavush, Vayots Dzor, and Yerevan). The entire country was selected because there is a high degree of variation in both social and physical differences across Armenia.

The sample size calculation was based on the number of food processing sites, slaughterhouses, and laboratories in Armenia that may encounter *Brucella* species during their routine work. We estimate that we were able to obtain over 50 % coverage across the country, with at least one respondent from each Marz for each high-risk group. We note and acknowledge that while a random selection of individuals from each high-risk area might be desirable, it was necessary to work with the Ministry of Economy in the selection to ensure both cooperation with private corporations and ensure a broad range of responses. A total of 306 professional staff were targeted for interviews. The questionnaire comprised three parts. The first part included questions about demographic characteristics, knowledge about animal brucellosis clinical signs of brucellosis, and

potential herd management practices that could pose a risk for brucellosis acquisition in animals. The second part of the questionnaire focused on attitudes of working groups and brucellosis, potential routes of transmission from animals to people, and information on practices posing a risk of brucellosis acquisition in humans. The third part of the questionnaire focused on work practices that they follow.



**Fig. 1** Map of Armenia with each of the Marzes (<https://hpnonline.org>).

The questionnaire was pretested to assess clarity and time requirements and modified in line with feedback from the pre-test. Questions were then translated into Armenian, a questionnaire was created and collected data were entered using Epi Info software (version 7.2).

### Interview procedure

In each group, the worker received either an email or an onsite interview which provided the objectives and the participant information sheet in Armenian. Respondents were told that participation in the study was voluntary and that the identification of the respondent would not be disclosed. At the end of the interview, they received the correct answers and public outreach information regarding the disease brucellosis and how they may be at risk in their occupation.



### *Ethics statement*

The respondents have explained the study aims and requested collaboration in the current study. Participants were asked for their consent. All the participants were informed about the aims of the study, methods, and the individual information will not be disclosed, and voluntary participation. The participant information questions were explained before starting individual interviews. Written consent with the participant's signature was not possible. Consent was recorded in the survey software. The current study, participant information sheet, and the consent form/method were approved by the Ministry of Economy of Armenia.

### **Results and discussions**

It is expected that the findings of this study will help devise future disease control programs and One Health interventions (Shumaila, et al, 2017).

A total of 306 respondents participated in this study. Demographic characteristics of the respondents: Food producer respondents were 50/50 male/female. Slaughterhouse workers were 100 % male. All respondents had at least 5 years of work experience in their field, with >45 % of food producers and >65 % of slaughterhouse workers having >21 years of experience. A total of 58.9 % of respondents were between 31-50 years old, with only 12 % under 30.

There was a 100 % awareness of animal and human brucellosis among the participants, and over 95 % of respondents correctly identified which animals can contract the disease. Only 19.6 % of food processors recognized the correct signs and symptoms of human brucellosis. Furthermore, 28.3 % believed it was either a respiratory disease or a skin disease. Interestingly, only 63.6 % of food processors, but 100 % of slaughterhouse workers, recognized that a human can become infected by handling/consuming raw milk or dairy products; however, 6.5 % and 2.7 % believed that the disease could be contracted by insects or raw fruits and vegetables, respectively. More than 91 % of respondents correctly identified the need for sanitary food passports, as well as the need for temperature-controlled transportation of food; 100 % also stated that they comply with country-specific safety regulations. 32.5 % of respondents believe they are very likely to contract brucellosis in their profession; however, over 91.3 % are required to use personal protective measures in their profession, which include laboratory coats (44.8 %), gloves (98.1 %), hard hats (65 %), masks/respirators (23.9 %), boots (41.3 %), or a special uniform (76.1 %).

Nevertheless, 47.8 % of respondents were required to wash their clothes at home, indicating that there is a significant risk of bringing contaminated clothing back into the home environment. This fact indicates a paradoxical situation where a considerable number of respondents believe that they are at risk of contracting brucellosis in their profession, despite the majority reporting compliance with personal protective measures and adherence to safety regulations. The finding that almost half of respondents are required to wash their work clothes at home raises concerns about potential contamination in domestic settings. This highlights the need for a more comprehensive approach to occupational safety, including proper laundering facilities and protocols.

Over 80 % of food processors were aware if they were processing *Brucella*-infected foods because of veterinary documents indicating results, with over 84 % slaughtered in a slaughterhouse. 80 % of respondents work in facilities with environmental monitoring programs. A total of 95.7 % of respondents have had a medical exam in the last 6 months as mandated by their place of work. In terms of opinions related to brucellosis in Armenia, over 96.5 % of respondents had a strong belief that milk and meat for processing should be under the control of government regulation and products be accompanied by veterinary records, 100 % of interviewees attached special importance to special safety regulations during meat and milk processing.

Since this is the first such study conducted in Armenia, we tried to study the published data to understand the relevance of the problem and our possible gaps and limitations. Thus, some studies confirm that risk factors for occupational groups were both animal exposure and raw milk ingestion. In contrast to the results of our study, there are published data showing that except for laboratory workers, few veterinarians, and dairy workers none had heard about brucellosis (Smita, et al, 2016). Several published data regarding the KAP surveys on brucellosis among different target groups in a lot of countries show that gaps and problems are present, and KAP surveys are a useful tool for the identification of those gaps. So, a KAP survey conducted among smallholder dairy farmers in Pakistan highlighted that the respondents with no formal education and those who had not heard of the disease displayed greater risky behavior. Poor understanding of the disease, the presence of multiple risky practices on the farm and at the household, and incorrect perception support the need for an educational awareness program to ensure the uptake of improved practices (Shumaila, et al, 2017). Another survey realized among dairy farmers in

Indonesia also justifies that the practice level of brucellosis surveillance and control is moderate, and it is necessary efforts to improve the situation (Kustiningsih, et al., 2023).

The study emphasizes the importance of continuous monitoring and evaluation of occupational health practices. The discrepancy between perceived risk and reported adherence to safety measures underscores the need for targeted interventions, such as improved education, training, and infrastructure support. Additionally, promoting collaboration between government regulatory bodies and industry stakeholders can enhance safety standards enforcement and contribute to a safer working environment.

### Conclusions

The KAP (Knowledge, Attitudes, and Practices) survey and questionnaire conducted by the Food Safety Inspection Body and Ministry of Economy marked a significant milestone. This initiative successfully spanned the entire nation, reaching out to slaughterhouse workers and food processors, crucial populations at high risk of contracting brucellosis – an endemic disease in the country. The findings of the study underscored a critical need for enhancing knowledge and understanding of brucellosis among food processors and slaughterhouse workers. The survey implies a dual recommendation. First, recognizing the need for sustained efforts to bridge the identified knowledge gaps, stakeholders should consider developing additional training programs. Secondly, while acknowledging the strides made in workplace safety by commercial entities, focused attention on refining high-risk practices is essential. This includes implementing strategies to enhance the safety of activities like washing uniforms at home. In conclusion, the comprehensive insights gleaned from this survey provide a foundation for targeted interventions to enhance awareness, improve practices, and ultimately mitigate the impact of brucellosis within the identified high-risk demographic in Armenia. Providing this data to the responsible organizations of the Public Health sector and collaborating with them will be important and will improve the situation regarding brucellosis in the country.

### References

1. Brucellosis-*Brucella* spp., in *Clinical Microbiology Procedures Handbook*, L.S. Garcia and H.D. Isenberg, Editors. (2007), ASM. - p. 16.6.1-16.6.5.
2. Chen, S., et al. (2014). Increasing threat of brucellosis to low-risk persons in urban settings, China. *Emerg Infect Dis*, . 20(1): - pp. 126-30 <http://dx.doi.org/10.3201/eid2001.130324>.
3. Corbel, M.J. Banai, M. (2005). Family III. Brucellaceae, Genus I. *Brucella*, in *Bergey's manual of systematic bacteriology*, D.R. Boone, R.W. Castenholz, and G.M. Garrity, Editors. Springer: New York. - pp. 370–386.
4. De Santis, R., et al. (2011). *Brucella*: Molecular diagnostic techniques in response to bioterrorism threat. *Bioterrorism & Biodefense*. S2: - p. 002 <http://dx.doi.org/10.4172/2157-2526.s2-004>.
5. Detailed Countries Disease Incidence. (2014) [cited 2012 28 February]; Available from: [http://www.oie.int/wahis\\_2/public/wahid.php/Diseaseinformation/statusdetail](http://www.oie.int/wahis_2/public/wahid.php/Diseaseinformation/statusdetail).
6. Dhanashekar, R., S. Akkinapalli, and A. Nellutla (2012). Milk-borne infections. An analysis of their potential effect on the milk industry. *Germs*. 2(3): - pp. 101-109.
7. Dragon, D. (2004). Brucellosis ICD-9 023; ICD-10 A23 (Undulant fever, Malta fever, Mediterranean fever), in *Control of communicable diseases manual*, D.L. Heymann, Editor. American Public Health Association: Washington. - pp. 82-84.
8. Galinska, E.M. Zagorski, J. (2013). Brucellosis in humans-etiology, diagnostics, clinical forms. *Ann Agric Environ Med*, 20(2): - pp. 233-238.
9. Kustiningsih, H., et al. (2023). Dairy farmers' knowledge, attitudes, and practices regarding the brucellosis surveillance and control program in Bogor, Indonesia. *Veterinary World* <https://doi.org/10.14202/vetworld.2023.126-133>.
10. Ning, P., et al. (2013). Identification and effect decomposition of risk factors for *Brucella* contamination of raw whole milk in China. *PLoS One*, 8(7) <http://dx.doi.org/10.1371/journal.pone.0068230>.
11. Rubach, M.P., et al. (2013). Brucellosis in low-income and middle-income countries. *Curr Opin Infect Dis*, 26(5): - pp. 404-412 <http://dx.doi.org/10.1097/qco.0b013e3283638104>.
12. Shumaila, A., et al. (2017). Knowledge, attitudes and practices (KAP) relating to brucellosis in smallholder dairy farmers in two provinces in Pakistan. *PLOS ONE* <https://doi.org/10.1371/journal.pone.0173365>.

13. Smita, S., Mangalgi, et al. (2016). Brucellosis in Occupationally Exposed Groups. Journal of Clinical & Diagnostic Research <https://doi.org/10.7860%2FJCDR%2F2016%2F15276.7673>.
14. Yagupsky, P. Baron, E.J. (2005). Laboratory exposures to brucellae and implications for bioterrorism. Emerg Infect Dis, 11(8) <http://dx.doi.org/10.3201/eid1108.041197>.
15. Zhen, Q., et al. (2013). Asymptomatic brucellosis infection in humans: implications for diagnosis and prevention. Clin Microbiol Infect, 19(9): - p. E395-7.
16. <https://hpnonline.org/Armenia-Map-Map-of-Armenia-3386631.html> Map of Armenia showing all Marz and Yerevan (accessed on 15.10.2023).

---

**Declarations of interest**

*The authors declare no conflict of interest concerning the research, authorship, and/or publication of this article.*

---

*Accepted on 02.11.2023  
Reviewed on 27.11.2023*



UDC 636.5:619:616.98:579.842.11

## Heat Stress and Cultivable Intestinal Bacteria of Lehmann Brown Hens

**N.A. Harutyunyan***Division of Food Safety and Biotechnology***Zh.T. Chitchyan, M.V. Badalyan, A.Z. Pepoyan***Armenian National Agrarian University*[natalya.harutyunyan@list.ru](mailto:natalya.harutyunyan@list.ru), [zh\\_chitch@yahoo.com](mailto:zh_chitch@yahoo.com), [badalyan.manvel@mail.ru](mailto:badalyan.manvel@mail.ru), [a pepoyan@gmail.com](mailto:a pepoyan@gmail.com)

### ARTICLE INFO

**Keywords:**

*culturomics,  
chicken,  
heat stress,  
gut microbiota,  
lecithinase activity*

### ABSTRACT

The use of genetic methods seems to have briefly pushed back the use of culture methods. Currently, a new technique developed based on the latter – culturomics, enables the discovery and study of expanded bacterial diversity using a large number of culture conditions and media. This study aims to investigate the influence of heat shock on the qualitative and quantitative content of cultivable gut bacteria of Lehmann Brown chickens from the “Arax” chicken factory. The chickens (5 months old, weighing 1.4-1.7 kg) of the “Arax” poultry factory in Armenia were transferred to a sterilized test room with the necessary conditions. After four days of maintenance in a new environment (temperature 25 °C), fecal samples were taken from the hens. After that, the hens were kept at 35 °C for a day, followed by another sampling conducted a day later. The current investigations have emphasized that the bacterial number and diversity of hen gut microbiota undergo changes under the influence of heat stress.

### Introduction

In the 19th century, the discovery of culture media stimulated the cultivation of microbiology (Wainwright and Lederberg, 1992). Particularly, this method was the first one to allow the assessment of microbiota structures of humans and animals (Lagier, et al. 2015, 2018). However, the utilization of genetic methods afterward inhibited the use of cultural media for a while (Gramberg, et al., 2023). Nevertheless, the development

of culturomics as a new technique allows to rediscover and investigate the expanding diversity of bacteria mainly due to the method of cultural media, (Abou Chacra, et al., 2024; Wan, 2023; Phelps, et al., 2023; Bonnet, et al., 2019; Lagier, et al., 2018) which is also widely implementing the capacities of microscopy (Ahmad, et al., 2023; Lim, et al., 2019; Kim, et al., 2023; Mulaw, et al., 2019; Hovnanyan, et al., 2015; Ghosh, et al., 2023). This technique, indeed, is competent

with metagenomics (Lian, et al., 2023; Huang, et al., 2023). Illnesses (Pepoyan, et al., 2015a, b) and stressful conditions (Ma, et al., 2023; Tan, et al., 2023) can influence the structure of human and animal (Shevchenko, et al., 2023; Mirzabekyan, et al., 2023; Tanelian, et al., 2023) gut microbiota. It was also illustrated that, for example, there exists a correlation between the qualities of *Escherichia* spp of physiologically robust and ailing individuals' gut microbiota (Shahinyan, et al., 2003; Stepanyan, et al., 2007). In parallel with this investigation, for animals, a correlation was indicated between blood protein and *E. coli* of their gut microbiota (Pepoyan, et al., 2020).

The poultry industry has improved genetics, nutrition, and management practices, resulting in fast-growing chickens; which, however, may have a stressful outcome for the birds. (Kpodo, et al., 2023; Campos, et al., 2023; Stefanetti, et al., 2023). On the other hand, high environmental temperatures are also able to alter poultry health and performance by causing heat stress. Heat stress elicits physiological, behavioral, and production changes in poultry (Wasti, et al., 2020; Garriga, 2006). Reduction in feed intake in heat-stress animals is an adaptive mechanism to minimize metabolic heat production. A significant decrease in feed intake, body weight gain, and feed efficiency has been reported in many studies conducted on birds and other animals (Nawaz, 2021). The birds' gut microbiota is changing, too (Brugaletta, et al., 2023). Considering the latter, the investigation of cultivated bacteria extracted from the gut microbiota of hens exposed to heat stress has served as the aim of the current study.

## Materials and methods

The chickens (30 Lehmann Brown hens, 5 months old, weighing 1.4-1.7 kg) of the "Arax" poultry factory of Armenia were transferred to a sterilized test room with the necessary conditions, where they were numbered. Chickens were fed with feed layer TOTAL POL 21 (Arndane Ltd, Armenia) made with a Dutch technique-Nuscience (<https://www.nuscience.eu>).

After 4 days of adaptation to the new conditions, fecal samples were taken of hens held at a temperature of 22-25 °C. Afterward, the birds were exposed to 35-38 °C heat stress. Then, these fecal samples were collected in respective test tubes and were immediately transferred to a microbiological laboratory for further analysis.

To investigate the effect of heat stress on the qualitative content of gut bacteria, the dilution of the fecal material has been organized according to Pepoyan and co-

authors (Pepoyan, et al., 2023; Balayan, et al., 2019). For examining the bacterial contents ENDO (Thermo Scientific Oxoid, USA) (24 hours (h); 37 °C), De Man, Rogosa and Sharpe (MRS) (48 h; 37 °C) and Egg yolk salt (EYS) (prepared on the base of Nutrient agar Himedia (HiMedia Laboratories Pvt. Ltd, India) (48 h; 37 °C) agars were used, and the dominant cultivable isolates (isolates from the most diluted samples) were investigated.

The isolates grown on agars were identified and counted according to Pepoyan and co-authors (Pepoyan, et al., 2023) for *Escherichia coli*. During the preliminary bacterial identification by morphology B-150 optical microscope (B-150 OPTIKA, OPTIKA S.r.l., Italy) has been used, too. The statistical analysis (t-test) was systemized through Excel 2016 and were confirmed by the Mann-Whitney test. The value  $p < 0.05$  was judged as significant.

## Results and discussions

### *Bacterial growth on ENDO, MRS, and EYS agars*

The studies emphasized that exposure to heat shock does not result in a quantitative disparity in the contents of cultivatable commensal *E. coli* and lactobacilli. In comparison, qualitative and quantitative differences were observed in the bacterial populations growing on EYS agar. Given the high concentration of sodium chloride (approximately 7.5 %) in EYS agar, it facilitates the growth of cocci and bacilli tolerant to sodium chloride in this medium (Ayaz, et al., 2022). On the other hand, the content of egg yolk (lecithin) in the EYS medium indicates the possible differentiation of bacteria with lecithinase activity within that medium (<https://pr.vwr.com>). Lecithinase is a phospholipase which affects lecithin. The presence of lecithinase in bacteria is important due to this ferment's potential role in the:

- pathogenicity of bacteria (Ghannoum, et al., 2000)
- identification of *Clostridium perfringens*, *Staphylococcus aureus*, *Pseudomonas aeruginosa* or *Listeria monocytogenes*
- detection of coagulase-positive *S. aureus*

It can also be used for differentiating some varieties of *Bacillus*.

According to the results, in control samples of EYS agar, bacterial colonies were noticed with up to 10<sup>-6</sup> – 10<sup>-7</sup> dilutions (Photo 1). They were primarily cocci, particularly ovoid diplococci (Figure 1A). Bacilli with different morphologies were present (Figure 2), with some of them also having lecithinase activity.



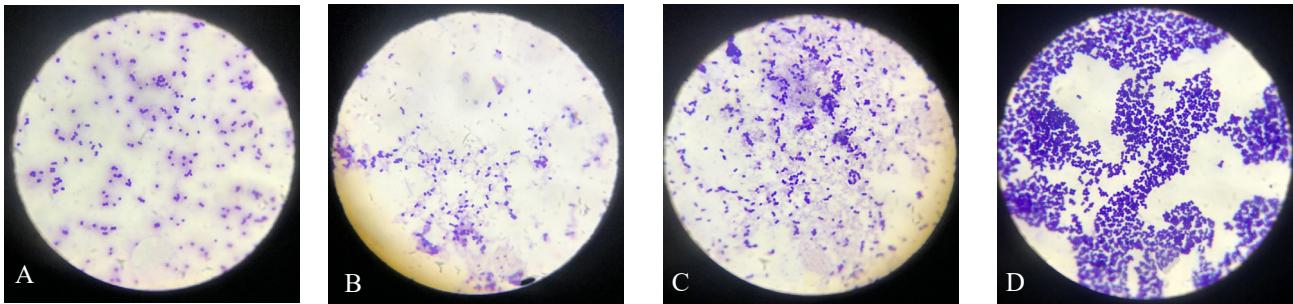

**Photo 1.** 1000x magnification of bacteria extracted from hens' microbiota (grown on EYS agar). After heat stress, *Staphylococcus spp.* was detected in one of the chickens (not *Staphylococcus aureus*, there is no lecithinase activity (D)).

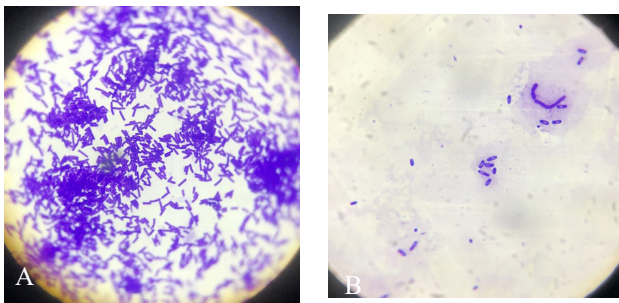

**Photo 2.** A-*Bacillus subtilis*., magnification 1000x; B-*Bacillus cereus*, magnification 2000x.

In only 1-2 control samples obtained from hens, sporulating bacilli with lecithinase activity were identified. Lecithinase activity is a sign of pathogenicity and is relevant to *Bacillus cereus* and to *Bacillus anthracis*. It is supposed that *Bacillus cereus* was indicated in chickens (Photo 2 B). Scummed, yellowish colonies with mucoid texture that lack lecithinase activity are supposedly other sporulating bacilli, for instance, grass bacillus - *Bacillus subtilis* (Photo 2 A).

#### *Bacterial growth on ENDO, MRS, and EYS agars after heat stress.*

The number of bacteria growing on EYS agar decreased until  $10^{-3}$  -  $10^{-4}$ , and in certain instances, the bacterial count from specific hens reached as low as  $10^{-1}$ . According to the literature, in chickens, streptococci and enterobacteria are the first ones to colonize gut microflora within the first few hours of their lives, then completely spread there during 24 hours. On the third day, lactobacilli, streptococci, enterococci, and coliforms are produced in different parts of the gastrointestinal tract (Coloe, et al., 1984).

The studies demonstrated that the decrease in the number of bacteria in birds exposed to heat stress is linked with

a predominance of enterococci, which is similar to the results in the investigated literature (Giraffa, 2022). Among enterococci, *Enterococcus faecalis* showcases quantitative dominance (30-45 %).

Enterococci are gram-positive, non-sporulative, catalase-negative (some strains demonstrate pseudo catalase activity), oxidase-negative, and lactic acid bacteria. Nearly all representatives of enterococci are non-motile and facultative anaerobes. They hydrolyze esculin and L-pyroglutamic acid b-naphthylamide, as well as are able to grow in a medium containing 4 % bile acid, the utilization of which serves as a means of differentiation. When observed under the microscope, enterococci appear as single cells or form pairs or chains. Their metabolism is fermentative, and the primary outcome of glycolysis is the production of L (+) lactic acid. Nowadays, out of 50 varieties identified, the most "popular" in dairy products are *Enterococcus faecalis* and *Enterococcus faecium*. These two strains are quite widespread and are typically resistant to unfavorable external conditions. They grow within a temperature range of 10-45 °C, in the presence of 6.5% NaCl, and at a pH level of 9.6. They are even able to survive at 60 °C after being exposed to heat for 30 minutes, categorizing them as non-sporulating, heat-resistant bacteria. The strains are usually detected in raw or heat-processed food, for instance, in raw or pasteurized milk, cheese, and other dairy products.

Stress (not only limited to heat) brings up various metabolic changes in the organism and affects the composition of gut microbiota. Typically, enterococci exhibit the highest titers, attributed to their exceptional adaptability (Mónica García-Solache, 2019, Ocejó et al., 2024; Repoila et al., 2022; Xu et al., 2024). Sporulative bacilli are also able to grow in the medium of EYS agar with a high concentration of sodium chloride. Colonies and bacilli with different morphologies have been discovered. Considering



the widespread utilization of probiotics in combating pathogens across humans (Pepoyan, et al., 2020, 2021; Sajankila et al., 2023; Beghetti et al., 2021; Bodke, et al., 2022; Balayan, et al., 2015; Latif, et al., 2023), animals (Merenstein, et al., 2023; Saha, et al., 2023; Marouf, et al., 2021; Mirzaei, et al., 2022; Pepoyan, et al., 2019), and even plants (Pepoyan, et al., 2020; Du et al., 2021; Khushboo, et al., 2023; de L Agüero et al., 2020; Harutyunyan, et al., 2022; Du, et al., 2021; Yun, et al., 2009), it is prudent to study the influence of various probiotics on the qualitative and quantitative composition of stress-resistant bacteria to avoid potential infections of organisms exposed to stress. Therefore, in hens' gut microbiota, quantitative and qualitative changes occur in response to heat stress, with a particular emphasis on changes related to enterococci.

### Conclusion

Current investigations have illustrated that, under heat stress, the bacterial variety and number of gut microbiota of hens undergo changes. Specifically, a decrease in the number of enterococci has been observed under heat stress conditions. Nevertheless, it is vital to acknowledge that these investigations are preliminary and require further genetic confirmation.

### References

1. Abou Chacra, L., Benatmane, A., Iwaza, R., Ly, C., Alibar, S., Armstrong, N., Mediannikov, O., Bretelle, F., Fenollar, F. (2024). Culturomics Reveals a Hidden World of Vaginal Microbiota with the Isolation of 206 Bacteria from a Single Vaginal Sample. // Arch Microbiol. -V. 206, - 20 p. <https://doi.org/10.1007/s00203-023-03742-2>.
2. Ahmad, A., Hettiarachchi, R., Khezri, A., Singh Ahluwalia, B., Wadduwage, DN., Ahmad, R. (2023). Highly Sensitive Quantitative Phase Microscopy and Deep Learning Aided with Whole Genome Sequencing for Rapid Detection of Infection and Antimicrobial Resistance. // Front Microbiol. - V. 14 <http://dx.doi.org/10.1101/2022.07.07.499154>.
3. Ayaz, M., Ali, Q., Jiang, Q., Wang, R., Wang, Z., Mu, G. Khan, S., Khan, A., Manghwar, H., Wu, H., et al. (2022). Salt Tolerant Bacillus Strains Improve Plant Growth Traits and Regulation of Phytohormones in Wheat under Salinity Stress. // Plants -V. 11 <https://doi.org/10.3390/plants11202769>.
4. Balayan, M., Manvelyan, A., Marutyanyan, S., Isajanyan, M., Tsaturyan, V., Pepoyan, A., Marotta, F., Trok, T. (2015). Impact of Lactobacillus acidophilus INMIA 9602 Er-2 and Escherichia coli M-17 on Some Clinical Blood Characteristics of Familial Mediterranean Fever Disease Patients from the Armenian Cohort. // Int. J. Probiot. Prebiot. - V. 10, - pp. 91-95.
5. Balayan, M., Pepoyan, A., Manvelyan, A., Tsaturyan, V., Grigoryan, B., Abrahamyan, A., Chikindas, M. (2019). Combined Use of Ebeam Irradiation and the Potential Probiotic Lactobacillus Rhamnosus Vahe for Control of Foodborne Pathogen Klebsiella Pneumoniae. // Ann. Microbiol. -V. 69 <http://dx.doi.org/10.1007/s13213-019-01522-2>.
6. Beghetti, I., Panizza, D., Lenzi, J., Gori, D., Martini, S., Corvaglia, L., and Aceti, A. (2021). Probiotics for Preventing Necrotizing Enterocolitis in Preterm Infants: A Network Meta-Analysis. Nutrients, 13(1), - 192 p. <https://doi.org/10.3390/nu13010192>.
7. Bodke, H., Jogdand, S. Role of Probiotics in Human Health. (2022). // Cureus. - V. 14 <http://dx.doi.org/10.7759/cureus.31313>.
8. Bonnet, M., Lagier, JC., Raoult, D., Khelaifia, S. (2019). Bacterial Culture Through Selective and Non-Selective Conditions: the Evolution of Culture Media in Clinical Microbiology. New Microbes New Infect. // - V. 34 <http://dx.doi.org/10.1016/j.nmni.2019.100622>.
9. Brugaletta, G., Laghi, L., Zampiga, M., Oliveri, C., Indio, V., Piscitelli, R., Pignata, S., Petracci, M., De Cesare, A., Sirri, F. (2023). Metabolic and Microbiota Response to Arginine Supplementation and Cyclic Heat Stress in Broiler Chickens. // Frontiers in physiology - V. 14 <https://doi.org/10.3389/fphys.2023.1155324>.
10. Campos, P., Schreier, L., Proszkowiec-Weglarz, M., Dridi, S. (2023). Cecal Microbiota Composition Differs under Normal and High Ambient Temperatures in Genetically Distinct Chicken Lines. // Sci Rep. -V. 13 <https://doi.org/10.1038/s41598-023-43123-9>.
11. Coloe, P., Bagust, J., Ireland, L. (1984). Development of the Normal Gastrointestinal Microflora of Specific Pathogen-Free Chickens. // J Hyg. -V. 92, - pp. 79–87 <https://doi.org/10.1017/s0022172400064056>.
12. de L Agüero, N., Frizzo, L.S., Ouwehand, A.C., Aleu, G., & Rosmini, M.R. (2020). Technological Characterisation of Probiotic Lactic Acid Bacteria as Starter Cultures for Dry Fermented Sausages. Foods (Basel, Switzerland), 9(5), - 596 p. <https://doi.org/10.3390/foods9050596>.
13. Du, G., Shi, J., Zhang, J., Ma, Z., Liu, X., Yuan, C., Zhang, B., Zhang, Z., & Harrison, M. D. (2021). Exogenous

- Probiotics Improve Fermentation Quality, Microflora Phenotypes, and Trophic Modes of Fermented Vegetable Waste for Animal Feed. *Microorganisms*, 9(3), - 644 p. <https://doi.org/10.3390/microorganisms9030644>.
14. Garriga, C., Hunter, R., Amat, C., Planas, J., Mitchell, M., Moretó, M. (2006). Heat Stress Increases Apical Glucose Transport in The Chicken Jejunum. *American journal of physiology. Regulatory, integrative, and comparative physiology*, - V. 290, - pp. 195–201 <https://doi.org/10.1152/ajpregu.00393.2005>.
  15. Ghannoum, M. (2000). Potential Role of Phospholipases in Virulence and Fungal Pathogenesis. // *Clin Microbiol Rev.* - V. 13, - pp. 122-143, table of contents <http://dx.doi.org/10.1128/cmr.13.1.122>.
  16. Ghosh, S., Sapkota, B., Rao, R., Patil, S., Rajkumar, C., Lakshminarayan, S. (2023). Expansion Microscopy: A Revolution in Diagnostic Pathology. // *J Microsc.* -V. 290, - pp. 3-9 <http://dx.doi.org/10.1111/jmi.13170>.
  17. Giraffa, G. Lactic Acid Bacteria: Enterococcus in Milk and Dairy Products, Editor(s): Paul, L., McSweeney, J.P. McNamara, Encyclopedia of Dairy Sciences (Third Edition), Academic Press, 2022, - pp. 151-159 <https://doi.org/10.1016/B978-0-08-100596-5.00848-9>.
  18. Gramberg, M., Knippers, C., Lagrand, R., van Hattem, JM., de Goffau, MC., Budding, A., Davids, M., Matamoros, S., Nieuwdorp, M., de Groot, V., et al. (2023). Concordance Between Culture, Molecular Culture and Illumina 16S rRNA Gene Amplicon Sequencing of Bone and Ulcer Bed Biopsies in People with Diabetic Foot Osteomyelitis. // *BMC Infect Dis* -V. 23, - 505 p. <https://doi.org/10.1186/s12879-023-08472-w>.
  19. Harutyunyan, N., Kushugulova, A., Hovhannisyan, N., Pepoyan, A. (2022). One Health Probiotics as Biocontrol Agents: One Health Tomato Probiotics. // *Plants (Basel)* - V. 11 <http://dx.doi.org/10.3390/plants11101334>.
  20. Hovnanyan, K., Marutyanyan, S., Pepoyan, A., Navasardyan, L., Trchounian, A. (2015). Transmission and Scanning Electron Microscopy of Contacts between Bacterial and Yeast Cells in Biofilms on Different Surfaces. // *Open Access Library Journal* -V. 2, - pp. 1-10 <http://dx.doi.org/10.4236/oalib.1101492>.
  21. Huang, Y., Sheth, R., Zhao, S., Cohen, L., Dabaghi, K., Moody, T., Sun, T., Ricaurte, D., Richardson, M., Velez-Cortes, F., et al. (2023). High-Throughput Microbial Culturomics Using Automation and Machine Learning. // *Nat Biotechnol.* - V. 41, - pp. 1424–1433 <http://dx.doi.org/10.1038/s41587-023-01674-2>.
  22. Kim, M., Park, J., Kang, M., Jeong, U., Jeong, D., Kang, N., Hwang, S., Youn, S., Hwang, B., Hyun, Y., Kim, D. (2023). Bacteria Detection and Species Identification at the Single-Cell Level Using Super-Resolution Fluorescence Imaging and AI Analysis. // *Biosens Bioelectron* - V. 240 <http://dx.doi.org/10.1016/j.bios.2023.115603>.
  23. Kpodo, K., Proszkowiec-Weglarz, M. (2023). Physiological Effects of in ovo Delivery of Bioactive Substances in Broiler Chickens. // *Front Vet Sci.* - V. 10 <http://dx.doi.org/10.3389/fvets.2023.1124007>.
  24. Khushboo, Karnwal, A., & Malik, T. (2023). Characterization and selection of probiotic lactic acid bacteria from different dietary sources for development of functional foods. *Frontiers in microbiology*, - V. 14, <https://doi.org/10.3389/fmicb.2023.1170725>.
  25. Lagier, J., Dubourg, G., Million, M., Cadoret, F., Bilen, M., Fenollar, F., Levasseur, A., Rolain, JM., Fournier, PE., Raoult, D. (2018). Culturing the Human Microbiota and Culturomics. // *Nat Rev Microbiol.* - V. 16, - pp. 540–550 <https://doi.org/10.1038/s41579-018-0041-0>.
  26. Lagier, J., Hugon, P., Khelaifa, S., Fournier, P., La Scola, B., Raoult, D. (2015). The Rebirth of Culture in Microbiology through the Example of Culturomics to Study Human Gut Microbiota. // *Clin Microbiol Rev.* - V. 28, - pp. 237-264 <http://dx.doi.org/10.1128/cmr.00014-14>.
  27. Latif, A., Shehzad, A., Niazi, S., Zahid, A., Ashraf, W., Iqbal, M. W., Rehman, A., Riaz, T., Aadil, R. M., Khan, I. M., Özogul, F., Rocha, J. M., Esatbeyoglu, T., & Korma, S. A. (2023). Probiotics: mechanism of action, health benefits and their application in food industries. *Frontiers in microbiology*, - V. 14 <https://doi.org/10.3389/fmicb.2023.1216674>.
  28. Lian, W., Mohamad, O., Dong, L., Zhang, L., Wang, D., Liu, L., Han, M., Li, S., Wang, S., Antunes, A., Fang, B., Jiao, J., Li, W. (2023). Culturomics- and Metagenomics-Based Insights into the Microbial Community and Function of Rhizosphere Soils in Sinai Desert Farming Systems. // *Environ Microbiome.* - V. 18 <http://dx.doi.org/10.1186/s40793-023-00463-3>.
  29. Lim, Y., Shiver, A., Khariton, M., Lane, K., Ng, K., Bray, S., Qin, J., Huang, K., Wang, B. (2019). Mechanically Resolved Imaging of Bacteria Using Expansion Microscopy. // *PLoS Biol.* -V. 17 <http://dx.doi.org/10.1101/622654>.

30. Ma, L., Yan, Y., Webb, R., Li, Y., Mehrabani, S., Xin, B., Sun, X., Wang, Y., Mazidi, M. (2023). Psychological Stress and Gut Microbiota Composition: A Systematic Review of Human Studies. // *Neuropsychobiology* -V. 82, - pp. 247-262 <http://dx.doi.org/10.1159/000533131>.
31. Merenstein, D., Pot, B., Leyer, G., Ouwehand, A., Preidis, G., Elkins, C., Hill, C., Lewis, Z., Shane, A., Zmora, N., Petrova, M., Collado, M., Morelli, L., Montoya, G., Szajewska, H., Tancredi, D., Sanders, M. (2023). Emerging Issues in Probiotic Safety: 2023 perspectives. // *Gut Microbes* - V. 15 <http://dx.doi.org/10.1080/19490976.2023.2185034>.
32. Mirzabekyan, S., Harutyunyan, N., Manvelyan, A., Malkhasyan, L., Balayan, M., Miralimova, S., Chikindas, M., Chistyakov, V., Pepoyan, A. (2023). Fish Probiotics: Cell Surface Properties of Fish Intestinal Lactobacilli and Escherichia coli. // *Microorganisms* -V. 11, - 595 p. <http://dx.doi.org/10.3390/microorganisms11030595>.
33. Mirzaei, A., Razavi, S.A., Babazadeh, D., Laven, R., & Saeed, M. (2022). Roles of Probiotics in Farm Animals: A Review. *Farm Animal Health and Nutrition*, 1(1), - pp. 17–25 <https://doi.org/10.58803/fahn.v1i1.8>.
34. García-Solache, M., Rice, L. (2019). The Enterococcus: a Model of Adaptability to Its Environment. // *ASM Journals Clinical Microbiology Reviews* - V. 32, No. 2 <https://doi.org/10.1128/cmr.00058-18>.
35. Mulaw, G., Sisay Tessema, T., Muleta, D., Tesfaye, A. (2019). In vitro Evaluation of Probiotic Properties of Lactic Acid Bacteria Isolated from Some Traditionally Fermented Ethiopian Food Products. // *Int J Microbiol.* - V. 2019 <http://dx.doi.org/10.1155/2019/7179514>.
36. Nawaz, A., Amoah, K., Leng, Q., Zheng, J., Zhang, W., Zhang, L. (2021). Poultry Response to Heat Stress: Its Physiological, Metabolic, and Genetic Implications on Meat Production and Quality Including Strategies to Improve Broiler Production in a Warming World. // *Frontiers in veterinary science* - V. 8 <http://dx.doi.org/10.3389/fvets.2021.699081>.
37. Ocejo, M., Mugica, M., Oporto, B., Lavín, J.L., Hurtado, A. (2024). Whole-Genome Long-read Sequencing to Unveil Enterococcus antimicrobial Resistance in Dairy Cattle Farms Exposed a Widespread Occurrence of Enterococcus lactis. // *Microbiology spectrum* – V. 8 <https://doi.org/10.1128/spectrum.03672-23>.
38. Pepoyan, A., Balayan, M., Arutyunyan, N., Grigoryan, A., Tsaturyan, V., Manvelyan, A., Dilanyan, E., Pitseno, I., Torok, T. (2015a). Antibiotic Resistance of E. coli of the Intestinal Microbiota in Patients with Familial Mediterranean Fever. // *Klinicheskaia Med.* -V. 93, - pp. 37–39.
39. Pepoyan, A., Balayan, M., Malkhasyan, L., Manvelyan, A., Bezhanyan, T., Paronikyan, R., Tsaturyan, V., Tatikyan, S., Kamiya, S., Chikindas, M. (2019). Effects of Probiotic Lactobacillus acidophilus Strain INMIA 9602 Er 317/402 and Putative Probiotic Lactobacilli on DNA Damages in the Small Intestine of Wistar Rats in vivo. // *Probiotics Antimicrob Proteins* -V. 11, - pp. 905-909 <http://dx.doi.org/10.1007/s12602-018-9491-y>.
40. Pepoyan, A., Chikindas, M. (2020). Plant-Associated and Soil Microbiota Composition as a Novel Criterion for the Environmental Risk Assessment of Genetically Modified Plants. // *GM Crops Food* -V. 11, - pp. 47-53 <http://dx.doi.org/10.1080/21645698.2019.1703447>.
41. Pepoyan, A., Harutyunyan, N., Grigoryan, A., Balayan, M., Tsaturyan, V., Manvelyan, A., Dilanyan, E., Torok, T. (2015b). The certain clinical characteristics of blood in patients with family Mediterranean fever disease of Armenian population. // *Klin. Lab Diag.* -V. 60, - pp. 46-47 <http://dx.doi.org/10.3389/fcimb.2024.1336752>.
42. Pepoyan, A., Manvelyan, A., Balayan, M., McCabe, G., Tsaturyan, V., Melnikov, V., Chikindas, M., Weeks, R., Karlyshev, A. (2020). The Effectiveness of Potential Probiotics Lactobacillus rhamnosus Vahe and Lactobacillus delbrueckii IAHAAHI in Irradiated Rats Depends on the Nutritional Stage of the Host. // *Probiotics Antimicrob Proteins* -V. 12, - pp. 1439-1450 <http://dx.doi.org/10.1007/s12602-020-09662-7>.
43. Pepoyan, A., Manvelyan, A., Balayan, M., Harutyunyan, N., Tsaturyan, V., Batikyan, H., Bren, A., Chistyakov, V., Weeks, R., Chikindas, M. (2023). Tetracycline Resistance of Escherichia coli Isolated from Water, Human Stool, and Fish Gills from the Lake Sevan Basin. *Lett Appl Microbiol.* - V. 76 <http://dx.doi.org/10.1093/lambio/ovad021>.
44. Pepoyan, A., Pepoyan, E., Galstyan, L., Harutyunyan, N., Tsaturyan, V., Torok, T., Ermakov, A., Popov, I., Weeks, R., Chikindas, M. (2021). The Effect of Immunobiotic/Psychobiotic Lactobacillus acidophilus Strain INMIA 9602 Er 317/402 Narine on Gut Prevotella in Familial Mediterranean Fever: Gender-Associated Effects. // *Probiotics & Antimicro. Prot.* - V. 13 <http://dx.doi.org/10.1007/s12602-021-09779-3>.
45. Pepoyan, A., Tsaturyan, V., Badalyan, M., Weeks, R., Kamiya, S., Chikindas, M. (2020). Blood Protein Polymorphisms and the Gut Bacteria: Impact of

- Probiotic *Lactobacillus Acidophilus* Narine on Salmonella Carriage in Sheep. // *Benef Microbes*. - V. 11, - pp. 183-189 <http://dx.doi.org/10.3920/bm2019.0138>.
46. Pepoyan, A., Tsaturyan, V., Manukyan, V., Egorov, I., Ilina, L. Novel Probiotic *Lactiplantibacillus plantarum* str. ZPZ as a Possible Candidate for “One Health” Probiotic. In: Ronzhin, A., Kostyaev, A. (eds). *Agriculture digitalization and organic production. Smart Innovation, Systems and Technologies. ADOP 2023*, 362. Springer, Singapore [http://dx.doi.org/10.1007/978-981-99-4165-0\\_13](http://dx.doi.org/10.1007/978-981-99-4165-0_13).
47. Phelps, C., Shapira, J., Laughlin, C., Meisel, M. (2023). Detection of Viable Commensal Bacteria in Murine Melanoma Tumors by Culturomics. // *STAR Protoc*. - V. 4 <http://dx.doi.org/10.1016/j.xpro.2023.102492>.
48. Repoila, F., Le Bohec, F., Guérin, C. (2022). Adaptation of the Gut Pathobiont *Enterococcus faecalis* to Deoxycholate and Taurocholate Bile Acids. // *Sci Rep*. - V. 12, 8485 <https://doi.org/10.1038/s41598-022-12552-3>.
49. Sajankila, N., Wala, S. J., Ragan, M. V., Volpe, S. G., Dumbauld, Z., Purayil, N., Mihi, B., & Besner, G. E. (2023). Current and future methods of probiotic therapy for necrotizing enterocolitis. *Frontiers in pediatrics*, - V. 11 <https://doi.org/10.3389/fped.2023.1120459>.
50. Saha, S., Fukuyama, K., Debnath, M., Namai, F., Nishiyama, K., & Kitazawa, H. (2023). Recent Advances in the Use of Probiotics to Improve Meat Quality of Small Ruminants: A Review. *Microorganisms*, 11(7) <https://doi.org/10.3390/microorganisms11071652>.
51. Shahinyan, A., Garibyan, J., Pepoyan, A., Karapetyan, O. (2003). Cancerolytic Action of *E. coli*. // *J. Nat. Sci*. - V. 1, - pp. 53–58.
52. Shevchenko, A., Shalaginova, I., Katserov, D., Matskova, L., Shiryayeva, N., Dyuzhikova, N. (2023). Post-stress Changes in the Gut Microbiome Composition in Rats with Different Levels of Nervous System Excitability. // *PLoS One*. - V. 18 <http://dx.doi.org/10.1371/journal.pone.0295709>.
53. Stepanyan, K., Balayan, M., Vassilian, A., Pepoyan, A., Trchounian, A. (2007). Growth Peculiarities and Some Characteristics of Membrane for Probiotic Strain of *Escherichia coli*. // *Memb. Cell Biol*. - V. 1, - pp. 333–335 <http://dx.doi.org/10.1134/s1990747807040095>.
54. Tan, H.E. (2023). The Microbiota-Gut-Brain Axis in Stress and Depression. *Front Neurosci*. // - V. 17 doi: 10.3389/fnins.2023.1151478.
55. Tanelian, A., Nankova, B., Cheriyan, A., Arens, C., Hu, F., Sabban, E. (2023). Differences in Gut Microbiota Associated with Stress Resilience and Susceptibility to Single Prolonged Stress in Female Rodents. // *Neurobiology of Stress* - V. 24 <https://doi.org/10.1016/j.ynstr.2023.100533>.
56. Tsaturyan, V., Manvelyan, A., Balayan, M., Harutyunyan, N., Pepoyan, E., Torok, T., Chikindas, M., Pepoyan, A. (2023). Host Genetics and Gut Microbiota Composition: Baseline Gut Microbiota Composition as a Possible Prognostic Factor for the Severity of COVID-19 in Patients with Familial Mediterranean Fever Disease. // *Front. Microbiol*. - V. 14 <http://dx.doi.org/10.3389/fmicb.2023.1107485>.
57. Tsaturyan, V., Poghosyan, A., Toczyłowski, M., Pepoyan, A. (2022). Evaluation of Malondialdehyde Levels, Oxidative Stress and Host-Bacteria Interactions: *Escherichia coli* and *Salmonella Derby*. // *Cells*. - V. 11 <http://dx.doi.org/10.3390/cells11192989>.
58. Wainwright, M., Lederberg, J. (1992). History of microbiology. // *Encyclop Microbiol*. - V. 2, - pp. 419–437.
59. Wan, X., Yang, Q., Wang, X., Bai, Y., Liu, Z. (2023). Isolation and Cultivation of Human Gut Microorganisms: A Review. // *Microorganisms*. - V. 11 <http://dx.doi.org/10.3390/microorganisms11041080>.
60. Wasti, S., Sah, N., Mishra, B. (2020). Impact of Heat Stress on Poultry Health and Performances, and Potential Mitigation Strategies. // *Animals* - V. 10 <https://doi.org/10.3390/ani10081266>.
61. Xu, W., Fang, Y., Zhu, K. (2024). Enterococci Facilitate Polymicrobial Infections. // *Trends in microbiology* - V. 32, - pp. 162–177. <https://doi.org/10.1016/j.tim.2023.07.010>.
62. Yun, J., Lee, K., Sung, Y., Kim, E., Lee, H., Choi, Y. (2009). Isolation and Characterization of Potential Probiotic *Lactobacilli* from Pig Feces. // *J Basic Microbiol*. - V. 49, - pp. 220-226. <http://dx.doi.org/10.1002/jobm.200800119>.
63. <https://www.nuscience.eu/species/poultry>. Challenges in poultry (accessed on 31.09.2023).

Accepted on 05.12.2023

Reviewed on 20.12.2023





UDC 636.4:619:616.9(479.25)

## Epidemiological Analysis of the Swine Perfringens Disease in the Aragatsotn Region

**M.A. Sargsyan**

Armenian National Agrarian University

[mariam.sargsyan.1960@mail.ru](mailto:mariam.sargsyan.1960@mail.ru)

### ARTICLE INFO

**Keywords:**

swine,  
Perfringens,  
*Clostridium perfringens*,  
epidemiology,  
intoxication

### ABSTRACT

Over the recent 20 years, for the first time, the disease of swine perfringens has been studied in the Aragatsotn region of RA and related epidemiological analysis has been conducted. To identify A, C, and D serological types of *Cl. Perfringens* and special diagnostic sera produced by the Kursk biofactory were used. It has been found that the main serological infection type of swine perfringens is C and sometimes A and D subtypes. In the pig breeding farms of the mentioned region about 6887 heads of swine (aging from 3 days to 1 year old) were registered. Per the research results, about 45 out of 72 communities were recognized as insecure/vulnerable. As to the above-stated animal number, it should be mentioned, that 1722 heads of swine fell down, whereas 5510 were considered bacteria carriers. Thus, as a result of epidemiological analysis, the morbidity (bacteria carrying rate), mortality, insecurity/vulnerability, and focality coefficients (indicators) have made 0.80 (80 %), 0.25 (25 %), 0.63 (63 %), and 122 animals, respectively.

### Introduction

*Perfringens* (anaerobic infectious enterotoxemia) disease takes a special position in the infectious disease pathology of farm, domestic and other animals, which has become widespread in many swine-breeding countries (Nesterov, 2003).

The disease pathogen (*Clostridium perfringens*) belongs to *Bacillaceae* family, genus *Clostridium*. According to antigenic properties, serological types (A, B, C, D, E, F)

produce alpha-, beta-, -iota-, epsilon-, kappa- exotoxins. During evolution, each type was adapted to one or more animal species. The above-mentioned types are similar to each other in morphological, cultural and biochemical properties, differing only in lethal poison. The latter destroys erythrocytes, blood vessels, capillaries and tissues. The serological types of the disease pathogen grow well in anaerobic nutrient media of Kitt-Tarozzi, milk and blood serum containing media causing intense gas formation and turbidity of the broth. Bacteria are sporulated in external

conditions, and encapsulated in environments rich in carbohydrates and proteins. According to the researchers, the capsula contains polysaccharides (D-glucose, D-galactose, N-acetyl galactose) and inulin acid, which contribute to the long-term preservation of bacteria in soil and cold water (Dunaev, 1982; Efimov, 1982; Urguev, 1987; Sheng and Cherniak, 1997; Bessarabov, et al., 2007; Francisco and Uzal, 2009). Anaerobic infectious enterotoxemia disease of pigs (*Perfringens*) according to Detri and Schennikov, was first reported in Hungary (1927) and Russia (1946), which affected newborn piglets in large numbers. Such pig farms have suffered heavy economic losses. It is an endemic disease, the causative agent of which are serological types C, A, D of *Cl. Perfringens*.

The disease is characterized by overfilling of the stomach, necrosis of the intestinal mucosa, hemorrhagic inflammation, gas accumulation, watery diarrhea (diarrhea) and disruption of the normal functioning of the nervous system. Attaching special attention to the development mechanism of severe course of the *Perfringens* disease it can be stated that it is endowed with high morbidity and mortality. According to the authors, in the pig-breeding farms of Hungary massive losses of piglets occurred due to *Perfringens*, which is followed by annual outbreaks for a long period (Altukhov and Dushenin, 1987; Urguev, 1987; Kudryashov, 1990; Satio, 1990; Czanderlova, et al., 2006; Salimov, 2006; Kudryashov and Svyatkovskiy, 2007; Sargsyan, 2012; Sidorchuk and Masimov, 2024). Complications of enteritis in newborn piglets can be caused by opportunistic bacteria, viruses and endoparasites belonging to the genera *Escherichia coli* and *Salmonella*.

Predisposing factors to the disease are low-viable piglets fed with low-quality colostrum, collective housing conditions, zoohygienic conditions, soil, feed, water contaminated with clostridia, and feed rich in monoproteins (Figure 1).

According to the author, the meat product made from the carcass of diseased and healthy but bacteria carrying



**Figure 1.** Bacteria carrying sow.

animals pose a certain risk to human health (food poisoning) (Sakurai, 1995; Sargsyan, 2014).

### Materials and methods

For the first time (2004-2023) the infection of swine *perfringens* was investigated in the Aragatsotn region and the related epidemiological analysis was conducted. The study was conducted at laboratory of the Research Center of Veterinary Medicine and Veterinary Sanitary Examination, at the Armenian National Agrarian University.

Considering the pluralism (diversity) of serological types of *Cl. Perfringens*, a problem arose to study the antigenic characteristics and its role in pig breeding farms. Therefore, in order to assess the epidemic situation, the well-known methods of diagnosis were used: epidemiological observation, clinical signs, patho-anatomical changes, microbiological, serological and biological experiments (Yefimova, 1982, Urguev, 1987, Raju and Sarker, 2007, Sargsyan, 2012, Nesterov, 2011). In the pig breeding farms of the mentioned region about 6887 heads of swine (aging from 3-day to 1-year-old) was registered. Per the research results, about 45 out of 72 communities was recognized as insecure/vulnerable. As to the above stated animal number, it should be mentioned, that 1722 heads of swine fell down, whereas 5510 were considered as bacteria carriers.

Spleen, kidneys, lymph nodes, liver, caecum, small intestine, and faeces of piglets older than 3 days served as materials for laboratory studies. For microbiological research the nutrient media of Kitt-Tarozzi liver broth, iron sulfate, Wilson Blair Agar, as well as meat peptone agar, meat peptone broth and sterilized milk were used (Antonov, et al., 1986). To determine the lethal dose (LD<sub>50</sub>) and serological types of the pathogen, 48 healthy rabbits weighing 3.0-3.5 kg each, guinea pigs weighing 450-500 grams, and white mice weighing 18-20 grams were selected. Per the principle of similarity, the experimental animals were divided into 4 groups.

Therefore, the 18-24 hour microbial culture was centrifuged at 3500-5000 rpm for 15 minutes and the supernatant was separated. Animals of each group were injected intramuscularly, intra-abdominally from the straining (exotoxin) of microbial culture with 1.5, 0.2, 0.15 ml dosages (Syurin, 1984; Fisher, et al., 2006). As an antigen, the pathogen "*Cl. perfringens*" isolated from pigs' excrement and the organs of fallen animals was used (Figure 2).



For the identification of serological types of *Cl. perfringens* A, C, D, polyvalent *E. coli* OKC, OKD, OKA and *Salmonella* A, B, C, D, E, a specific diagnostic sera produced by the Kursk biofactory were used according to the neutralization reaction. The minimum lethal dose was determined according to Reed and Muench method (Syurin, et al., 1984). The epidemiological analysis of the studied region has been conducted per the morbidity (bacteria carrying rate), mortality, insecurity/vulnerability and focality indicators (Nikitin and Voskoboynik, 1999).

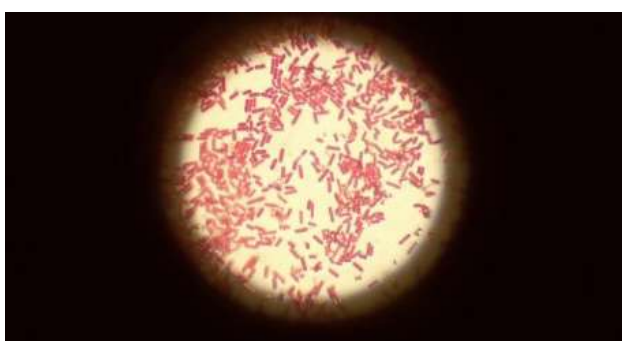

**Figure 2.** Microbial image of *Cl. Perfringens*.

### Results and discussions

To identify the infection intensity, recentness, extent of its spread, number of affected animals, insecurity mode and outbreak periodicity, an epidemiological survey of the communities was carried out. Taking into account the similarities between the clinical signs and pathoanatomical changes of *Perfringens* and a number of other diseases, particularly, *Escherichia*, *Salmonellosis*, as well as food poisoning, differential diagnosis was made using bacteriological and serological methods. As a result, the activity of the poison secreted by the mentioned pathogens was ruled out. Sick piglet showed a decrease in the body temperature, depression, abdominal distension, body tremors, bloody diarrhea and uncoordinated movements.

As a result of dissection of the carcasses of animals fallen from *Perfringens* abdominal distension, blood stroke in the cecal, small and duodenal intestines, in stomach, rennet mucous membrane, hemorrhagic inflammations, as well as changes in the tissues of the kidneys, liver and heart were observed. In the sub-cells of individual parts of the body of animals that have died from the above-mentioned disease,

jelly-like effusion and serohemorrhagic exudate was detected, while the abdomen and thoracic cavities were filled with blood fluid. As a matter of fact, the animals died from asphyxiation (Figure 3).

Clostridia are activated as a result of disruption of the motor/motility and juice production function of the digestive tract, as a result, the antimicrobial properties of the gastric juice are declined and the alkalinity ( $pH$  9,10) of intestines increases. Under the created favorable conditions, the toxin of bacteria is absorbed into the blood and destroys erythrocytes, the endothelium of vessels and capillaries, the parenchyma of the liver and kidneys (Figure 4 and Figure 5).



**Figure 3.** Serohemorrhagic exudate in the tissue subcells of the piglets.



**Figure 4.** Hemorrhagic inflammation in the piglet's intestines.

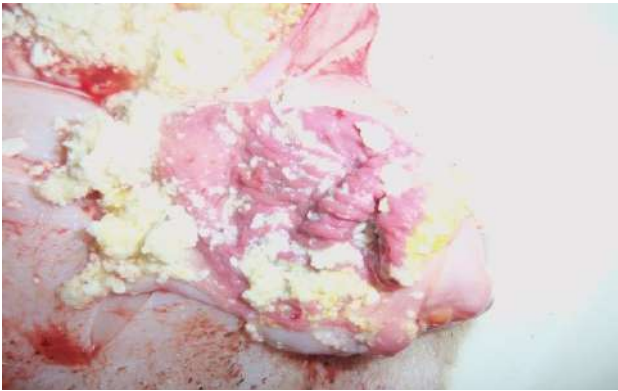

**Figure 5.** Catarrhal inflammation of the gastric mucosa of a newborn piglet.



**Figure 8.** Hemolysis of erythrocytes.



**Figure 6.** Microbial growth of *Cl. Perfringens* in Wilson-Blair and milk medium.

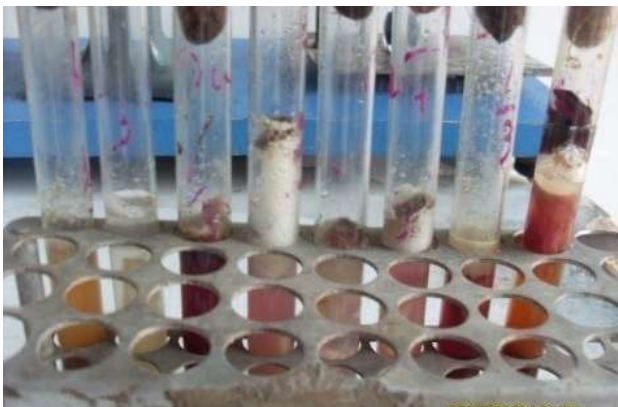

**Figure 7.** The growth of *Cl. Perfringens* in Kitt-Tarozzi medium.

In the result of microbiological research, microbial growth (with unpleasant smell, abundant gas formation, turbidity of the medium, black colonies, milk coagulation) peculiar to *Cl. Perfringens* was observed in the seedings implemented from the internal organs and feces of healthy and fallen animals. The reason of black colonies formation is probably the transformation of sodium sulfate into iron sulfate (Figure 6 and Figure 7). The results of epidemiological research have indicated that throughout investigation period, in different settlements of the Aragatsotn region the disease of swine *Perfringens* has been recorded. We think that the main cause of the disease outbreak is the neonatal (endo) infection.

It is noteworthy that the animal-based food product and raw material infected with the toxins of *Cl. Perfringens* can entail to mild food poisoning up to life-threatening consequences. As a result of the biochemical activity of the microbial poison, the erythrocytes of rabbits and rams were destroyed within 2-3 minutes (Figure 8). Serological types of microbial antigen were determined using pathogens isolated from organs of fallen animals and appropriate diagnostic immune sera. As a result of the neutralization reaction, it was determined that the bacteria carrying state of the animals and the cause of death are the serological types C, A, D of *Cl. Perfringens*, which made 58.8, 20.5, and 10.6 %, respectively.

As a result, the lethal dose of *Cl. Perfringens* ( $LD_{50}$ ) in case of infection of experimental animals made 95-100 %.

The epidemiological research and analysis was carried out based on the relevant data considering the age, morbidity, mortality and focality factors, as well as the index of insecurity/vulnerability. The results of epidemiological

research have testified that in different settlements of the Aragatsotn region the disease of swine *Perfringens* was recorded. In the above stated insecurity conditions, the average indices of morbidity (bacteria carrying state), mortality, insecurity and focality have made 0.80 (80 %), 0.25 (25 %), 0.63 (63 %), and 122 animals, respectively.

Summarizing the indicators of epidemiological research analysis, it was found out that 45 (63 %) out of 72 communities was recognized as insecure/vulnerable.

### Conclusion

1. The epidemic situation is multifactorial, and the level of veterinary and sanitary conditions is of particular importance.
2. Sick piglets and healthy bacteria carriers are considered to be the source of the disease pathogen. In this regard, the disease can occur as a result of infection penetrating from the outside and as a result of bacterial contamination of the sows' udder and teats.
3. The serological C type of *Cl. perfringens* isolated from swines is endowed with higher pathogenesis than A and D types.
4. The carcass and meat product contaminated with the toxins of *Cl. Perfringens*, are forbidden to use, since they endanger human health.

### References

1. Altukhov, N.M., Dushenin, N.V., Shakhov, A.G., Morgunova, V.I., Sharonin, S.A. (1987). Anaerobic enterotoxemia of piglets // *Veterinary Medicine*. - M., - № 5, - pp. 41-42 (in Russian).
2. Antonov, B.I., Borisova, V.V., Volkova, P.M. (1986). Laboratory research in veterinary medicine/Bacterial infections: Directory.- M.: Agropromizdat, - 352 p.
3. Bessarabov, B.F., Vatutin, A.A., Voronin, E.S. (2007). Infectious diseases of animals / Ed. A.A. Sidorchuk, - M.: KolosS, - 671 p. (in Russian).
4. Czanderlova, L., Hlozek, P., Chamelar, D., Lany, P. (2006). Clostridium perfringens in suckling piglets with diarrhea and its PCR typing and pre-balance in the Czech Republic in 2001-2003 // *Veterinarni Medichina*. - vol. 51, - № 9, - pp. 461-467 <http://dx.doi.org/10.17221/5578-vetmed>.
5. Deepa Raju, Mahfuzur R. Sarker (2007). Production of small, acid-soluble spore proteins in clostridium perfringens nonfoodborne gastrointestinal disease isolates.// *Can. J. Microbiol.* - vol. 15, - № 3, - pp. 514-518 <http://dx.doi.org/10.1139/w07-016>.
6. Dunaev, G.V. (1982). The causative agent of infectious anaerobic enterotoxemia / In the book: *Veterinary microbiology: Textbook* / Ed. E.V. Kozlovsky and P.A. Emelianenko. - M.: Kolos, - pp. 226-230 (in Russian).
7. Francisco, A., Uzal, I., Juliann Saputo, Samesta Sayced, Jorge, E. (2009). Development Application of New Mouse Models to Study the Pathogenesis of clostridium perfringens type C Enterotoxemias.// *Inf. Immune*. - vol. 77, - № 12, - pp. 5291-5299 <http://dx.doi.org/10.1128/iai.00825-09>.
8. Kudryashov, A.A. (1990). Pathological and morphological changes in the intestines of newborn piglets with colibacillosis, anaerobic enterotoxemia and VGTS // *Veterinary Medicine*, - M. - № 6, - pp. 36-39 (in Russian).
9. Kudryashov, A.A., Svyatkovsky, A.V. (2007). Infectious diseases of animals.- Saint Petersburg. Moscow. Krasnodar, - 607 p. (in Russian).
10. Nesterov, I.A. (2003). Evolutionary transformations of infectious anaerobic enterotoxemia (*Perfringens*) of animals in the North Caucasus in the modern period // *Veterinary Bulletin* - "Entropos", - V. 27, № 3, - pp. 24-37 (in Russian).
11. Nesterov, I.A. (2011). Epizootological analysis of pathogenicity factors of the causative agent of perfringens in animals // *Veterinary Bulletin*. - "Entropos", - V. 57, - № 2, - pp. 23-27 (in Russian).
12. Nikitin, I.N., Voskoboynik, V.F. (1999). Organization and economics of veterinary business: Textbook for university students - 4th ed., revised and supplemented - M.: Humanit. ed. VLADOS center, - 384 p. (in Russian).
13. Salimov, V.A. (2006). Pathomorphological changes in the intestines of piglets during experimental enterotoxemia // *Veterinary pathology*, - № 1, - pp. 98-100 (in Russian).
14. Sargsyan, M.A. (2012). The role of the microbe Clostridium perfringens in the infectious pathology of animals // *Bulletin of ANAU* - № 1, - pp. 96-98.
15. Sargsyan, M.A. (2014). Carcass and meat product contamination with Clostridium perfringens // *Mater. of intl. scientific conf. on the problem of food security and biodiversity*. - Yerevan: ANAU Publishing House, - pp. 244-247.
16. Satio, M. (1990). Production of enterotoxin by

- clostridium perfringens derived from humans, animals, foods and the natural environment in Japan // Journal Food prof. - № 53, - pp. 115-118 <http://dx.doi.org/10.4315/0362-028x-53.2.115>.
17. Sheng, L., Cherniak, R. (1997). Structure of the capsular polysaccharide of Clostridium perfringens hobbs 10 determined by NMR spectroscopy. // J. Carbohydrate Research, - vol. 305, № 1, - pp. 65-72 [http://dx.doi.org/10.1016/s0008-6215\(97\)00280-2](http://dx.doi.org/10.1016/s0008-6215(97)00280-2).
18. Sidorchuk, A.A., Masimov, N.A., Krupalniksh, et al. (2024). Textbook / edited by A. Sidorchuk, 2nd ed., revised and supplemented. - Moscow: INFRA-M, - 954 p. (in Russian).
19. Syurin, V.N., Belousova, R.V., Fomina, N.V. (1984). Veterinary Virology. - M.: Publishing house Kolos, - 376 p. (in Russian).
20. Urguev K.R. (1987). Clostridiosis of animals. - M.: Rosselkhozizdat, - 182 p. (in Russian).
21. Yefimova, M.G. (1982). Isolation of purified TETA-hemolysin from Clostridium perfringens type A and its use for titration of toxins and serums // JMEI, № 7, - pp. 40-43 (in Russian).

---

*Accepted on 23.10.2023*

*Reviewed on 01.12.2023*





UDC 663.252.1

# The Investigation of the Untapped Winemaking Potential of the Grape Variety “Hastakot”

**A.H. Gabrielyan, G.B. Iskandaryan**

Armenian National Agrarian University

[artwine750@gmail.com](mailto:artwine750@gmail.com), [iskandaryangreta06@gmail.com](mailto:iskandaryangreta06@gmail.com)

## ARTICLE INFO

**Keywords:**

grape variety “Hastakot”,  
rosé wine,  
red wine,  
sensory evaluation,  
flavor profile

## ABSTRACT

Research works demonstrate a rising demand for high-quality wine in Armenia. Our objective was to produce premium red and rosé wines using the relatively unexplored grape variety “Hastakot”. Throughout the research, we utilized various winemaking technologies to produce red and rosé wines of the grape variety “Hastakot”. Simultaneously, multiple physicochemical and sensory attributes were investigated in the produced must and wine. The obtained results highlight the ability to make unique wines from the grape variety “Hastakot”, indicating a potential market impact and gaining consumer appreciation.

## Introduction

Red wines are made of red grape varieties. The latter differ from white wines not only in color, but also in flavor and astringency. Red wine is richer in substances extracted from the solid parts of grapes and useful microelements (Gabrielyan, 2021).

The hallmark of red wine is its brilliant crimson hue, devoid of any black or brown undertones. It should possess a harmonious, full-bodied character, delicately velvety texture, and exhibit a subtle balance of acidity and astringency. The careful selection of grape varieties plays a pivotal role in red wine production. Grapes should contain an ample amount of coloring substances (Muradyan and Aghajanyan, 2012).

Rosé wines are made from red grape varieties. There are

several techniques available for making rosé wines. The most prominent ones include:

**“Gravity separation of grape must”** (Saignée): The production of top-quality rosé wines often relies on using this technique. The principle of this method is based on the natural separation of grape juice, typically around 40-50 % of the total volume, during grape processing, solely due to the force of gravity. This separated must is then fermented following the technique used in white wine production. This particular style of winemaking finds significant popularity in France, especially in regions like Provence and Burgundy.

**Pressing:** The core of the technique involves pressing red grapes, post destemming and crushing, until the must with the desired color and composition is obtained.

Subsequently, the obtained must undergoes standard procedures for white wine fermentation.

**Moderate infusion:** This is regarded as the most popular technique globally; it involves pouring the destemmed and crushed mass into a container for maceration. The maceration continues until the winemaker determines that the desired amount of phenolic substances has been extracted. Following this process, the mass is pressed and proceeds to fermentation.

**Separation of liquid mass during fermentation:** In this scenario, the grapes undergo destemming and crushing before being directed to the fermentation tank without immediate pressing. As the fermentation progresses and a satisfactory amount of phenolic compounds is extracted, the winemaker decides to separate the liquid part of the fermentation mass. This separated liquid continues to ferment in a distinct container (Pascal Ribereau-Gayon and Denis Dubourdiou 2006).

## Materials and methods

In light of the outlined goal, we have defined the following key objectives:

Examine “Hastakot” grape variety.

Assess the untapped winemaking potential of “Hastakot” grape variety by producing both red and rosé wines of this particular grape variety.

Scrutinize the physicochemical indicators throughout the winemaking procedures.

Analyze the olfactory attributes of the resulting wines.

The subject of the research is “Hastakot” grape variety and the red and rosé wines produced from it. The raw material for making red and rosé wines was “Hastakot” grape variety, a local variety found in individual vines or small groups within the old vineyards of the Meghri region. Several clones of this variety have been discovered and are currently under study. The upper part of a young vine is light green with a subtle rosé tint, while the newly sprouted leaves display a light green color with a faint red hue, and they are slightly pubescent. The grape bunches are medium-sized, cylindrical or cylindrical-conical, with varying levels of density. The fruit is typically medium to large, round, and black. The skin is of medium thickness and firmness, and the fruit is juicy with a pleasant taste (Melyan, et al., 2019).

The grapevine of “Hastakot,” cultivated in the national grape collection vineyard, was utilized in the production

of red dry table wine. The grapes were harvested at the point of technical ripeness to create dry red wines. The harvested grapes were carefully transported in small boxes to the winery to prevent damage. The grapes were then destemmed and crushed using a horizontal roller crusher-destemmer. Subsequently, a mono pump was utilized to transfer the crushed mass to a tank, where yeast was added to initiate fermentation. The fermentation process continued for 7 days, followed by a 5-day maceration period with the grape skins. Once the fermentation was complete, the pulp was pressed. After pressing, the wine was pumped to a tank where malolactic bacteria were introduced to initiate malolactic fermentation. Finally, the wine was poured into 25-liter glass containers.

The rosé wine was also made from “Hastakot” grape variety using appropriate equipment and auxiliary materials. The grapes were harvested during the period of technical ripeness, transported from the vineyards to the winery in small boxes, and were destemmed. Only the gravity fraction was collected during the pressing process. After pressing, the must was transferred to a container. Bentonite was added to clarify the must. After the must was clarified, it was racked. Three days after the commencement of fermentation, aeration was applied to the wine. Throughout the entire fermentation period, the sugar content in the must was assessed daily, influencing the pace of fermentation – whether to accelerate or decelerate. Additionally, in case of rose wines, the wine was transferred into 25-liter glass containers.

All the research carried out during the grape ripening process, as well as investigations related to grapes and wines were conducted in the educational laboratory of the EVN Wine Academy.



**Picture 1.** Wine storage containers.



All applied methods are endorsed by the International Organization of Vine and Wine (OIV) and adhere to international standards (OIV, 2016, ISO 5495:2005, ISO 4120:2021 (International Organization of Vine and Wine, “Compendium of International Methods of Wine and Must Analysis”, OIV-18 RUE D’AGUESSEAU-75008.-PARIS, Muradyan, et al., 2017).

The results of the conducted research were compared with the provisions of current legislation, including GOST-32030-2013, GOST P 52523-2006, and GOST P 55242-2012. Additionally, they were assessed against the regulatory document set forth by the “International Organization of Vine and Wine” (OIV-MA-C1-01), which specifies the maximum permissible limits.

## Results and discussions

In the concluding month of the ripening process for “Hastakot” grape variety, an examination was carried out to assess the content and changing dynamics of the specified physicochemical indicators. It is crucial to note that sampling for each grape variety was conducted at regular 7-day intervals.

The period for observing changes in indicators spans three weeks, during which the sugar content increased from 128 g/l to 211 g/l, total acidity decreased from 8.3 g/l to 7.5 g/l, and malic acid content dropped from 1.9 g/l to 1.5 g/l. Notably, there was an observed increase in the concentration of nitrogen substances during this timeframe.

These observations capture the content and dynamics of changes in various physicochemical indicators in wines produced from the extensively studied “Hastakot” grape variety (Table 1, 2).

Anthocyanins are red pigments primarily found in the grape skin, occasionally in the fruit itself, and they possess a structure similar to flavonoids (Table 3). The color of anthocyanins is notably influenced by pH levels; in general, lower pH values result in a more stable compound, which contributes to the red coloration. During the fermentation process, phenolic substances emerge and undergo continuous transformations (Jacobson, 2006).

Various flavor characteristics of wine made of “Hastakot” grape variety were assessed and compared using a rating method of sensory evaluation.

**Table 1.** The content of some physicochemical indicators of the grape samples “Hastakot”\*

INDICATORS					
Sugar content, g/l	Total acidity, g/l	pH	NH <sub>4</sub> <sup>+</sup> , mg/l	YAN, mg/l	Malic acid, mg/l
128	8.3	2.75	100	119.7	1.9
158	7.7	2.95	118	278	1.8
211	7.5	3.1	139	315.2	1.5

**Table 3.** The content of total phenols and anthocyanins in the examined wines.

Samples	Indicators	
	Total phenols, mg/l	Total anthocyanins, mg/l
Red wine	2940	608
Rosé wine	2586	128,9

**Table 2.** The content of some physicochemical indicators in the examined wines\*

Physicochemical indicators	Alcohol	Total acids	Volatile acidity	Extract	Brought extract	Sugar	pH	Free SO <sub>2</sub>	Total SO <sub>2</sub>	Reductons
Unit of measurement	Vol. %	g/l	g/l	g/l	g/l	g/l	-	mg/l	mg/l	mg/l
Red wine	12.8	5.1	0.4	28.9	28.9	0.1	3.1	45.9	133.6	1.39
Rosé wine	12.6	5.6	0.3	29.3	28.9	0.1	3.0	47	109.5	1.40

\*Composed by the authors.

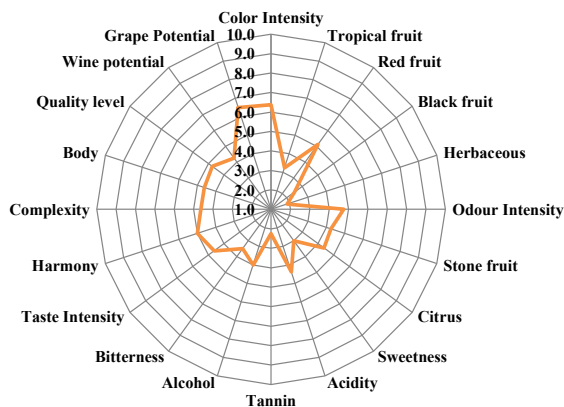

**Picture 2.** The aroma wheel of "Hastakot" rosé dry wine (composed by the authors).

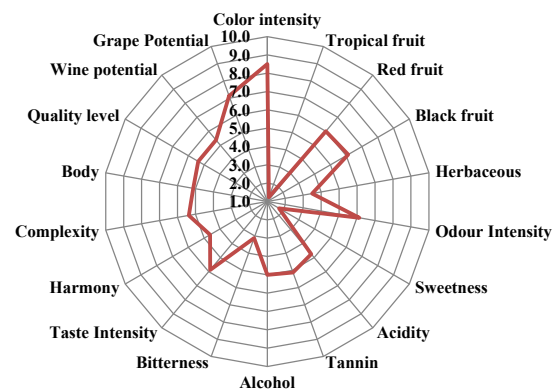

**Picture 3.** The aroma wheel of "Hastakot" red dry wine (composed by the authors).

The results are presented below. Fifteen specialists participated in the tasting. Initially, tasting participants identified a range of characteristics using the descriptive method. These descriptors were subsequently categorized into groups, with a specific emphasis on highlighting the most prominent attributes. Following this, the intensity of these characteristics was rated using a 1-to-10-point scale. Upon summarizing the final results, aromatic wheels were developed to represent the sensory indicators of the wines (Wang, 2019).

According to the sensory indicators, the rosé wine made of the grape variety "Hastakot" can be characterized. The color of the rosé wine was rated as quite intense, with noticeable fruit aromas-primarily red fruits and very little tropical notes. No green aromas were detected. The overall intensity of the general aromas was considered above average, with the presence of observed red berries, rated at a medium intensity. The sweetness of the wine was evaluated as very low, while acidity was rated as medium. The amount of tannins in the rosé wine made from "Hastakot" grape variety was estimated to be low, which is highly favorable for the light rosé wine. The overall flavor intensity of the wine received a high rating. Based on the evaluations, it can be concluded that the rosé wine made of "Hastakot" grape variety is harmonious.

The red wine derived from "Hastakot" grape variety exhibits a notably high color intensity. It features distinct fruity aromas, with a prevailing presence of black fruit notes and a substantial presence of red fruit aromas. Notably, there are no discernible tropical fruit aromas, and only a few herbal hints were detected in the wine. The overall intensity of the wine's aromas was rated as above

average. The sweetness of the wine was assessed as very low, while its acidity was found to be quite high. The wine exhibited a notable elevation in tannin levels, indicating an astringency presence. The alcohol sensitivity is moderate, and bitterness is low. The overall flavor intensity of this red wine, made of "Hastakot" grape variety, was also rated above average.

In summary, this wine is generally regarded as having a medium harmony and above-average aromatic complexity. Based on the final evaluation, this wine is categorized as having medium potential. It is noteworthy, however, that the winemaking potential of the "Hastakot" grape variety itself was assessed as high.

## Conclusion

"Hastakot" grape variety and the capabilities of making rosé and red wines of it were investigated, resulting in the determination that it is indeed feasible to produce wines of this grape variety that adhere to international standards. Notably, the overall quality of both rosé and red wines received an above-average rating. Additionally, the potential of these wines, assessed based on the characteristics of sensory indicators, exceeded the average standard. The assessment, rooted in the sensory indicators of wine, highlighted an above-average potential for wines derived from "Hastakot" grapes.

The research has revealed captivating perspectives on the winemaking capabilities of "Hastakot" grape variety. Nonetheless, we firmly advocate for a pressing need for more comprehensive and profound research in the future, a commitment we have consistently undertaken.

**References**

1. Gabrielyan, A.H. (2021). Grape and wine quality control: The role of chemical and organoleptic analyzes in winemaking, Yerevan, - pp. 3-48 (in Armenian).
2. ISO 5495:2005 - Sensory analysis — Methodology <https://www.iso.org/standard/31621.html>.
3. International Organisation of Vine and Wine <https://www.oiv.int/>.
4. International Organisation of Vine and Wine. “Compendium of International Methods of Wine and Must Analysis”, OIV-18RUED’AGUESSEAU-75008.- PARIS, Edition 2016. - Vol. 2. - 762 p.
5. Jean, L. Jacobson (2006). Introduction to Wine Laboratory Practices and Procedures. United States of America: Springer Science + Business Media, inc, - 375 p.
6. Melyan, G., Safaryan, D., Nersisyan, A. (2019). Ampelography, Yerevan, - pp. 61-70 (in Armenian).
7. Muradyan, Z., Aghajanyan, Zh. (2012). Winemaking and juice production, Yerevan (in Armenian).
8. Muradyan, Z., Mikayelyan, M., Avetisyan, A. (2017). Methodological instructions for the investigation of physicochemical indicators of wine. ANAU, Yerevan, - pp. 23-55 (in Armenian).
9. Pascal Ribereau-Gayon, Denis Dubourdieu (2006). Handbook of Enology - The Microbiology of Wine and Vinifications (2nd Edition); John Wiley & Sons Ltd, England <http://dx.doi.org/10.1002/0470010363>.
10. Wang, Q.J., Spence, C. (2019). Is complexity worth paying for? Investigating the perception of wine complexity for single varietal and blended wines in consumers and experts. Aust. J. GrapeWineRes, - pp. 248-250 <http://dx.doi.org/10.1111/ajgw.12382>.

---

*Accepted on 06.11.2023*  
*Reviewed on 05.12.2023*



UDC 637.12.04/.07(749.25)

## Cow Milk Total Protein Analysis and Daily Intake Estimation in Armenia

**A.S. Hovhannisyan, M.R. Beglaryan, D.A. Pipoyan***Center for Ecological-Noosphere Studies, NAS RA***N. Merendino***Department of Ecological and Biological Sciences (DEB), Tuscia University, Italy*[astghik.hovhannisyan@cens.am](mailto:astghik.hovhannisyan@cens.am), [meline.beglaryan@cens.am](mailto:meline.beglaryan@cens.am), [david.pipoyan@cens.am](mailto:david.pipoyan@cens.am), [merendin@unitus.it](mailto:merendin@unitus.it)

### ARTICLE INFO

**Keywords:**

*milk,  
proteins,  
Kjeldahl method,  
24H-recall,  
FFQ,  
daily intake,  
nutrients*

### ABSTRACT

Protein plays a critical role in both the nutrition and biological functions of milk, which is an important part of a balanced diet. In this study, we installed and implemented the fully automated Kjeldahl method, enabling the precise determination of the total protein content in cow milk. The investigation involved cow milk samples collected from Yerevan markets, representing 9 producers, over the years 2021 and 2022. The mean total protein content in the analyzed milk samples was found to be 2.93 g per 100 g. To determine the significance and contribution of milk protein in the adult population's diet in Armenia, the daily protein intake through milk consumption was evaluated. Two consumer clusters were identified: one with moderate milk consumption (0.067 kg per day) and another with higher intake (0.208 kg per day). The contribution of milk protein to the overall protein intake in the diet of the adult population ranged from 2.62 % to 8.13 %. Despite varied levels of milk protein consumption, it is essential to acknowledge that Armenian protein sources extend beyond milk.

### Introduction

Milk, a remarkably intricate fluid, comprises a diverse array of constituents, with primary components including water, lipids, sugars, and proteins. Additionally, it contains trace levels of vitamins and minerals, among other bioactive compounds (Goulding, et al., 2020). Globally, over 6 billion individuals incorporate milk and its derivatives into their diets, underscoring its high importance in human nutrition (FAO, 2018). Projections for 2022 indicate worldwide milk production reaching

nearly 930 million tons, reflecting a 0.6 percent growth from 2021 (FAO, 2022). Milk stands out for its protein content, housing a diverse array of more than 100 distinct protein types, categorized into three nitrogen fractions: abundant caseins, serum or whey proteins (comprising lactalbumin, lactoglobulin, blood serum albumin, and immunoglobulins), and the nonprotein nitrogen fraction, which encompasses milk fat globule membrane proteins alongside a wide spectrum of enzymes and hormones (Dupont, 2011).

Due to its high protein content, milk serves as a vital source of essential amino acids in the human diet (Wolfe, 2015; Goulding, et al., 2020).

In Armenia, milk and dairy products have an important role in the local diet. Over the past decade (2012-2022), milk production has consistently ranged from 618.2 thousand tonnes (the lowest in 2012) to 758.2 thousand tonnes (the highest in 2017). In 2022, there was a decrease in milk production compared to previous years, totaling 623.1 thousand tonnes. The nation exhibits a high degree of self-sufficiency in milk production, ranging from 82 % to 93% (ArmStat, 2023). Considering the importance of milk nutrients, particularly proteins, in the diet of the Armenian adult population, a knowledge gap emerges regarding how these nutrients contribute to the nutrition of the population.

International authorities have established Dietary Reference Values (DRVs) and protein intake recommendations for consumers. These guidelines suggest an average requirement (AR) ranging from 0.66 to 0.8 grams per kilogram of body weight per day, as well as a Population Reference Intake (PRI) of 0.83 grams per kilogram of body weight per day, among other parameters (WHO/FAO/UNU, 2007; EFSA NDA, 2012). Armenia, as a member of the Eurasian Economic Union (EEAU), aligns itself with the Customs Union Technical Regulation for food product labeling (TR CU, 2011). This regulation encompasses diverse stipulations for labeling food products, including the specification of the average daily requirement for essential nutrients, such as protein, which has been established at 75 grams per day (TR CU, 2011).

Numerous methods are available for assessing protein content in food items, including spectrophotometric techniques, the Duran method, the Lowry method, and the Biuret method, among others (Jiang, 2014). One of the most widely adopted methodologies is the Kjeldahl method, initially designed for the brewing industry in 1883 and subsequently adapted, with modifications, for application in various food industries, including dairy production (Evers and Hughes, 2002; Goulding, et al., 2020). Despite significant updates to the Kjeldahl method and its equipment in recent years, the fundamental three-step approach involving digestion, distillation, and titration for determining protein content in dairy products has remained unaltered (Dupont, 2011; Licon, 2022). This method calculates total protein content based on nitrogen levels in milk, employing a nitrogen-to-protein conversion factor of 6.38 (FAO/WHO, 2019). It is noteworthy that the Kjeldahl method does not differentiate between protein-based nitrogen and non-protein nitrogen, encompassing inorganic and organic nitrogen compounds, thereby

providing a total protein measurement based on the total unspecified nitrogen content in milk (Evers and Hughes, 2002; Licon, 2022).

The primary objectives of this study encompass the quantification of protein content in locally produced and imported cow milk, the evaluation of cow milk consumption rates within the adult population of Armenia, and the estimation of daily protein intake derived from cow milk among Armenia's adult population. This research seeks to provide valuable insights into the nutritional dynamics of milk consumption in Armenia, shedding light on the role of milk proteins in the dietary habits of the adult population.

The work was supported by the Science Committee of RA, in the frames of the research project 20TTTCG-4A001 on "Strengthening scientific and methodological capacity for assessing food security and nutrients".

## Materials and methods

### Milk sampling

The sampling of cow milk was done in 2021 and 2022 from the various markets in the city of Yerevan. The total number of samples was 10 from 9 cow milk producers and from 1 individual producer (Table 1).

Each milk sample consisted of 3 to 4 sub-samples of each type of the product. To prepare a milk sample with an average weight of 250 mL for laboratory analyses, sub-samples from the same producer were mixed (GOST 26809.1-2014).

**Table 1.** The cow milk sample list by years\*

Year of sampling	Sample Code	Product	Producer
2021	MN1	Prostokvasheno	Danone Russia
	MN2	Laktel	Lactalis Ukraine SC
	MN3	Biokat 3.2 %	Biokat Ltd
	MN4	Bonilat	Bonilat Ltd
	MN5	Bandivan	Bandivan Ltd
2022	MN6	Prostokvasheno	Danone Russia
	MN7	Chanakh	Chanakh Co.Ltd
	MN8	Marianna 3.2 %	Marianna Ltd
	MN9	Ani	Tamara & ANI Ltd
	MN10	Farm milk	Individual producer

\*Composed by the authors.



All the milk samples were pasteurized (i.e. heat-treated). Before the analyses, the samples were kept at 4 °C.

#### *Protein analysis methodology*

All analyses were carried out at the Center for Ecological-Noosphere Studies (CENS) of the National Academy of Sciences of Armenia. In this study, the fully automated Kjeldahl method was installed and implemented, enabling precise determination of total protein content in milk. Within the 20TTTCG-4A001 research project, a new fully automated Kjeldahl Analyzer K1100F (Hanon Advanced Technology Group Co., Ltd, China) with Graphite Digester system (Hanon Advanced Technology Group Co., Ltd, China) equipped with a waste gas collection hood, was acquired. The analyses methodology was undergoing some modernization. Sample pre-treatment was performed following GOST, the Association of Official Agricultural Chemists (AOAC) and VELP Scientific methodology (GOST 34454-2018; AOAC 991.20; VELP Scientific, 2013), as well as the automatic Kjeldahl Analyzer product manual. Milk samples, before analyses were brought to room temperature and were stirred in the beaker using a magnetic stirrer. After 5 mL of sample was added into 250 mL Kjeldahl digestion tube and in each tube were added catalyst: 3.5 g of potassium sulfate and 0.1 g of copper sulfate pentahydrate, 20 mL of concentrated sulphuric acid (96-98 %) and 5 ml of hydrogen peroxide. The tubes were gently shaken and loaded into the Graphite Digester under the following parameters: 15 min 150 °C, 15 min 250 °C, 40 min 420 °C. The digested samples were cooled down to 50-60 °C and put into the automatic Kjeldahl Analyzer. Beforehand the system was prepared and loaded with the necessary solvents: sodium hydroxide (32 % solvent), boric acid (4 % with indicators: methylene blue and bromocresol green), distilled water, and as titrant solution sulfuric acid (0.1N). All chemicals used were of analytical grade and were used as received without any further purification and were obtained from Carlo Erba (Italy) and Chem-Lab NV (Belgium).

The second part of analysis, which involved distillation and titration, was conducted using the following parameters: 70 mL of sodium hydroxide, 50 mL of dilution water, and 30 mL of boric acid. For titration, the sulfuric acid solution mentioned above was used.

The nitrogen-to-protein conversion factor for milk of 6.38 was used (FAO/WHO, 2019). The data for each sample were automatically calculated by the Automatic Kjeldahl

Analyzer as a percentage of nitrogen and a percentage of total proteins. Each sample was analyzed 3 times. The blank sample and standard solution of ammonium sulfate of 1.4 mg/mL nitrogen content for the quality assurance and quality control (QA/QC) of analysis were used. The mean of the obtained standard was 1.33 mg/mL (standard deviation of  $\pm 0.104$  mg/mL). Also, the calibration coefficient K-mean value (equal to one) was used for the calibration of the standard.

#### *Milk consumption and protein intake assessment*

The data on cow milk consumption among the Armenia's adult population from 18 to 80 years old and above was obtained via 24-hour recall and FFQ (food frequency questionnaire) methods (Pipoyan, et. al, 2023). The data was collected in 2021 by well-trained interviewers, using pre-designed forms of questionnaires. The total number of interviewed residents was 1400 from all 10 marzes of Armenia: Ararat, Armavir, Kotayk, Aragatsotn, Gegharkunik, Lori, Tavush, Shirak, Vayots Dzor, Syunik and from the capital city Yerevan. The response rate of milk consumers was 3.3 %.

The daily intake (*DI*) of total protein via the consumption of cow milk by Armenia's adult population was evaluated and calculated using the following formula:

$$DI=IR \times C, \quad (1)$$

where *IR*- is the mean daily consumption (ingestion rate) of cow milk among the adult population of Armenia (g/day), *C* is the mean amount of protein in cow milk samples (g/100 g) converted to 1g base.

The statistical one-way analysis of variance (ANOVA) test was used to identify the variance and normality of survey data. Statistical treatment of the survey data was done using IBM SPSS software version 28 (SPSS Inc., Chicago, IL, USA).

## **Results and discussions**

### *Total protein in cow milk*

The data from Kjeldahl analyses is presented in Table 2. The total protein and total nitrogen contents in cow milk samples from 9 different producers over 2 years vary from 0.449 to 0.694 g/100 g, with a total mean of 0.555 g per 100 g of milk, and from 2.81 to 3.14 g/100g, with a mean of 2.93 g in 100g of milk, respectively.

**Table 2.** Mean of total protein and nitrogen contents in cow milk from local markets of Yerevan (g/100 g)\*

Year of sampling	Samples	Total Nitrogen content (mean)	SD**	Total Protein (mean)	SD
2021	MN1	0.694	0.005	3.14	0.024
	MN2	0.678	0.010	3.07	0.044
	MN3	0.661	0.004	2.99	0.019
	MN4	0.620	0.013	2.81	0.059
	MN5	0.627	0.014	2.84	0.065
2022	MN6	0.459	0.003	2.93	0.02
	MN7	0.452	0.002	2.88	0.02
	MN8	0.453	0.012	2.89	0.07
	MN9	0.456	0.015	2.91	0.10
	MN10	0.449	0.008	2.86	0.05
Total mean	0.555	0.109	2.93	0.105	

Notes: \*\*SD-standard deviation

\*Composed by the authors.

The lowest nitrogen and protein contents in the 2021 and 2022 samples were found in Bonilat (MN4) and the individual milk producer's (MN10) milk samples, measuring 0.620 and 2.81 g/100 g, and 0.449 and 2.86 g/100 g, respectively. The highest levels of nitrogen and protein were detected in the samples of Prostokvasheno (MN1 and MN6), with values of 0.694 and 3.14 g/100 g, and 0.459 and 2.93 g /100 g, respectively (Table 2). In accordance with Technical Regulation 033/2013 of the Customs Union, total protein in milk must be not less than 2.8 % in 100 g (TR CU, 2013). All the analyzed samples met this requirement.

Recent studies have reported varying protein levels in cow milk, ranging from 3.56 to 3.85 g/100 g (Parmar, et al. 2020; Yasmin, et al., 2020). These values are 1.21 and 1.31 times higher than the results obtained in this current research. However, it's important to note that protein levels in cow milk can vary depending on factors such as breed, individuality, stage of lactation, and the health and nutritional status of the animal (Vincent, et al., 2016).

The mean total protein value of 2.92 grams per 100 g of milk serves as an important reference point for assessing the nutritional characteristics of the milk samples. Furthermore, the standard deviation (SD), calculated to be approximately 0.105 grams per 100g of milk, indicates the degree of variability in protein content among the samples. A higher SD signifies greater variability, suggesting that some milk samples deviate notably from the mean protein

content, while a lower SD indicates more consistency in protein content among the samples. These findings provide essential insights into the protein content of the examined milk samples, enabling a better understanding of the variability and quality of milk products. This information is invaluable for both consumers and producers in ensuring consistent nutritional value in dairy products and making informed dietary choices.

#### *Milk consumption and protein intake*

The average daily consumption of cow milk was 263 g per day. Notable, no significant differences in consumption rates were reported between males and females, as determined by the analysis of variance (ANOVA). Besides, the consumption rates showed no statistical significance when comparing consumers and non-consumers of cow milk among the adult population of Armenia. This was addressed by the K-mean cluster test, revealing two groups of consumers with varying weekly consumption rates (Table 3).

In cluster 1, individuals consumed approximately 234.5 g (0.2345 kg) of milk twice a week, resulting in a daily average consumption of 0.067 kg/day. This cluster represents a moderate milk consumption pattern. In cluster 2, the consumption rate was notably higher, with individuals consuming approximately 487.2 g (0.4872 kg) of milk three times a week, leading to a daily average consumption of 0.208 kg/day. Cluster 2 reflects a more frequent and higher milk consumption pattern compared to cluster 1.

**Table 3.** Daily average milk consumption in clusters\*

Clusters	Daily Consumption, kg/day	Consumption Frequency, per week	Daily Average Consumption, kg/day
Cluster 1	0.2345	2 times	0.067
Cluster 2	0.4872	3 times	0.208

**Table 4.** Daily total protein via cow milk (g/day) intake in clusters\*

Clusters	Daily average milk consumption	Daily total protein intake
Cluster 1	67	1.9631
Cluster 2	208	6.094

\*Composed by the authors.

These findings provide valuable insights into the diversity of milk consumption habits among different clusters in Armenia. Understanding such consumption patterns is essential for dietary planning, nutritional recommendations, and addressing specific dietary needs within distinct population groups. The daily average consumption values presented in the Table 3 can serve as reference points for assessing milk intake and its contribution to the overall diet in these clusters.

The calculation of daily total protein intake in the two identified clusters, based on the mean protein content of 2.92 grams per 100g of milk and daily average consumption values, provides insights into the nutritional aspects of milk consumption.

In the cluster 1, the average milk consumption is around 67 g/day per individual, resulting in a daily protein intake of about 1.9631 grams from milk. This cluster exhibits a moderate daily protein intake from milk consumption. In contrast, cluster 2 stands out with a higher daily average milk consumption of approximately 208 g/day, leading to a daily protein intake of about 6.094 grams from milk. This cluster demonstrates a notably higher daily protein intake from milk consumption compared to cluster 1. These findings highlight significant variations in daily protein intake patterns within different clusters of milk consumers.

To understand the role of milk in meeting this nutritional requirement, we calculated the percentage of protein contribution from milk based on daily consumption patterns in Armenia. Our analysis revealed that milk, as a dietary source, contributes approximately 2.62 % - 8.13 % of the daily protein intake.

Further studies and international comparisons can provide valuable insights into regional dietary trends and the extent to which milk and other dietary sources contribute to meeting nutritional requirements.

The multidiscipline nature of our study allowed for an in-depth exploration of the interrelationships between cow milk protein content, consumption patterns, and daily protein intake within the Armenian adult population. Understanding these interdependencies is crucial for gaining insights into the nutritional dynamics of milk consumption.

## Conclusion

The assessment of daily protein intake through milk consumption in Armenia has provided valuable insights, playing a pivotal role in tailoring dietary recommendations to ensure dietary patterns align with regulatory standards

and the health needs of populations. While varying levels of milk protein contribution to daily intake have been observed, it is essential to acknowledge that a comprehensive understanding of protein sources in the Armenian diet extends beyond milk alone. Therefore, to provide a more comprehensive and detailed insight into dietary protein sources, future research should include wider variety of food products. This will enable a more thorough understanding of the contributions of various foods to the overall diet and establish a strong basis for science-based recommendations on nutrition and balanced diets in Armenia. Furthermore, conducting additional studies and international comparisons can provide valuable context for optimizing dietary choices and enhancing nutritional standards.

## References

1. AOAC 991.20. Nitrogen (Total) in Milk. Application note F&F-K-002-2013/A1.
2. ArmStat (2023). RA national food balances by food product groups/product types, indicators and years [https://statbank.armstat.am/pxweb/hy/ArmStatBank/ArmStatBank\\_7%20Food%20Security/FS-1-2022.px/?rxid=9ba7b0d1-2ff8-40fa-a309-fae01ea885bb](https://statbank.armstat.am/pxweb/hy/ArmStatBank/ArmStatBank_7%20Food%20Security/FS-1-2022.px/?rxid=9ba7b0d1-2ff8-40fa-a309-fae01ea885bb).
3. Dupont, D., Grappin, R., Pochet, S., Lefier, D. (2011). MILK PROTEINS | Analytical Methods. Encyclopedia of Dairy Sciences, - pp. 741–750 <http://dx.doi.org/10.1016/b978-0-12-374407-4.00428-3>.
4. EFSA NDA (2012). Scientific Opinion on Dietary Reference Values for Protein. EFSA Journal 2012;10(2):2557, - 66 p. <http://dx.doi.org/10.2903/j.efsa.2012.2557>.
5. Evers, J. M., Hughes, C. G. (2002). Analysis, Chemical Analysis. Encyclopedia of Dairy Sciences, - pp. 34–40 <http://dx.doi.org/10.1016/b0-12-227235-8/00015-8>.
6. FAO (2018). Dairy Market Review: Rome <https://www.fao.org/markets-and-trade/publications/detail/en/c/1437816>.
7. FAO (2022). Dairy Market Review: Emerging trends and outlook 2022. Rome <https://www.fao.org/3/cc3418en/cc3418en.pdf>.
8. FAO/WHO (2019). Nitrogen and protein content measurement and nitrogen to protein conversion factors for dairy and soy protein-based foods: a systematic review and modelling analysis. Review, Paris, France, 94 <https://www.fao.org/3/ca8862en/CA8862EN.pdf>.

9. GOST26809.1-2014. Milk and milk products. Acceptance regulations, methods of sampling and sample preparation for testing. Part 1. Milk, dairy, milk compound and milk-contained products <http://dx.doi.org/10.3403/30306175>.
10. GOST 34454-2018. Dairy products. Determination of protein content by the Kjeldahl method.
11. Goulding, D.A., Fox, P.F., O'Mahony, J.A. (2020). Milk proteins: An overview. *Milk Proteins*, 21–98 <http://dx.doi.org/10.1016/b978-0-12-815251-5.00002-5>.
12. Jiang, B., Tsao, R., Li, Y., Miao, M. (2014). Food Safety: Food Analysis Technologies/Techniques. *Encyclopedia of Agriculture and Food Systems*, - pp. 273–288 <http://dx.doi.org/10.1016/b978-0-444-52512-3.00052-8>.
13. Licon, C.C. (2022). Proximate and Other Chemical Analyses. *Encyclopedia of Dairy Sciences (Third edition) 2022*, - pp. 521-529 <https://doi.org/10.1016/B978-0-12-818766-1.00344-5>.
14. Parmar, P., Lopez-Villalobos, N., Tobin, T.T., Murphy, E., McDonagh, A., Crowley, Sh.V., Kelly, A.L., Shalloo, L. (2020). The effect of compositional changes due to seasonal variation on milk density and the determination of season-based density conversion factors for use in the dairy industry. *Foods*, 9, 1004 <http://dx.doi.org/10.3390/foods9081004>.
15. Pipoyan, D., Stepanyan, S., Beglaryan, M., Mantovani, A. (2023). Assessment of Heme and Non-Heme Iron Intake and its Dietary Sources among Adults in Armenia. *Nutrients* 2023, 15, 1643 <http://dx.doi.org/10.3390/nu15071643>.
16. TR CU (2011). Technical Regulation of the Customs Union (TR CU 022/2011) on food products in terms of their labeling, 15.
17. TR CU (2013). Technical Regulation of the Customs Union (TR CU 033/2013) on Safety of Milk and Dairy Products.
18. VELP Scientific (2013). N/Protein Determination in Milk according to the Kjeldahl method.
19. Vincent, D., Elkins, A., Condina, M.R., Ezernieks, V., Rochfort, S. (2016). Quantitation and identification of intact major milk proteins for high-throughput Lc-Esi-Q-ToF MS analyses. *PLOS ONE* 11(10) <http://dx.doi.org/10.1371/journal.pone.0163471>.
20. WHO/FAO/UNU (2007). Protein and amino acid requirements in human nutrition. Report of a Joint WHO/FAO/UNU Expert Consultation. WHO Technical Report Series, No 935, - 284 p. <http://dx.doi.org/10.1111/j.1467-3010.1987.tb00040.x>.
21. Wolfe, R. (2015). Update on protein intake: importance of milk proteins for health status of the elderly. *Nutr Rev. Suppl* 1(Suppl 1):41-7 <http://dx.doi.org/10.1093/nutrit/nuv021>.
22. Yasmin, I., Iqbal, R., Liaqat, A., Khan, W.A., Nadeem, M., Iqbal, A., Chughtai, M.F.J., Rehman, S.J.U., Tehseen, S., Mehmood, T., Ahsan, S., Tanweer, S., Naz, S., Khaliq, A. (2020). Characterization and comparative evaluation of milk protein variants from Pakistani dairy breeds. *Food Sci Anim Resour.* 40(5):689-698 <http://dx.doi.org/10.5851/kosfa.2020.e44>.

---

*Accepted on 31.10.2023*  
*Reviewed on 23.11.2023*



UDC 664.858

## Using Alternative Raw Materials in Sugar Confectionery Production

N.G. Hovhannisyan, H.V. Mkhitarian, G.B. Aperyanyan, R.S. Hayrapetyan

Armenian National Agrarian University

[narinehovhannisyan1984@mail.ru](mailto:narinehovhannisyan1984@mail.ru), [hvmkhitarian@gmail.com](mailto:hvmkhitarian@gmail.com), [aperyanyan79@gmail.com](mailto:aperyanyan79@gmail.com), [ruzanna\\_hayrapetyan@mail.ru](mailto:ruzanna_hayrapetyan@mail.ru)

### ARTICLE INFO

**Keywords:**

*marmalade,  
pumpkin,  
sea buckthorn,  
puree,  
secondary raw materials*

### ABSTRACT

A novel recipe and production technology for sugar confectionery, specifically marmalade, has been developed through scientific and experimental research. The findings affirm that pumpkin and sea buckthorn purees can effectively substitute traditional plum and apple purees, eliminating the need for various coloring agents. The suggested product represents a domestically-produced marmalade, particularly in the food market, and this endeavor will play a crucial role in advancing both marmalade production and the development of the raw material base.

### Introduction

The global trends in food processing emphasize the utilization of alternative raw materials and the advancement of innovative technological processes in the food industry (Kalidas, 2020). Among health-friendly vegetable-based products rich in biologically active substances, marmalade stands out prominently (Emelike, 2019).

Within the European Union member states, marmalade composition adheres to specific European standards. The production process involves mixing ingredients and steaming at 10 °C until achieving the designated “exact content of dry matter” (Council directive 2001/113/EC of 20 December 2001, Official Journal of the European Communities).

The global confectionery market, valued at 199.8 billion USD in 2020, displayed positive dynamics with an average annual growth rate of 3.2 %. The sugar confectionery market achieved a value of 53.5 billion US dollars in 2020. Projections suggest a substantial growth of 22.6 % in the global sugar confectionery market by 2025, with an anticipated market size of US\$ 65.6 billion. Marmalade products rank third in this segment, emerging as the most popular confectionery items (Skobelskaya, 2021).

In recent years, the market has seen a scarcity of fruit marmalade containing natural dietary fibers with physiological value (Chhikara, et al., 2022). Jelly-type marmalade lacks fibers due to the use of dyes, flavorings, and acidifiers (Zubchenko, 1999; Tefikova, 2018).



While jelly marmalades incorporate dyes, flavorings, and acidifiers, fruit marmalades employ fruit purees with gelling agents, enhancing their nutritional value (Emelike, 2019).

Key components in fruit marmalade production include fruit purees, sugar, molasses, citric acid, various pigments, and gelatinizers like agar-agar, agaroid, pectin, and occasionally gelatin or xanthan gum, the latter gaining popularity in recent years (<https://yandex.ru/patents/>).

Pumpkin fruits are deemed essential in dietary and therapeutic regimens for conditions such as atherosclerosis, heart, intestines, kidneys, liver, and gall bladder diseases (<https://calorizator.ru>). Sea buckthorn fruits are rich in vital microelements, including iron, manganese, and magnesium, along with an array of vitamins and organic acids crucial for bodily functions. Fruits are rich in a variety of essential vitamins, including A, C, E, P, K, B1, B2, B3, and B6. They also contain significant amounts of ascorbic acid (ranging from 50 to 450 mg) and folic acid (0.79 mg per 100 g of fruit). Additionally, fruits contain various organic acids and sugars, constituting about 9 % of the fruit's composition (<http://agroecoarm.com>).

Recent years have witnessed several attempts to incorporate sea buckthorn fruit juice in marmalade production (Magomedov, et al., 2017). Marmalades are traditionally crafted from fruits and vegetables harvested at the technical ripening stage, ensuring that pectin substances are in the optimal state for effective jelly formation.

## Materials and methods

The research concentrated on examining marmalade samples prepared from commercially available pumpkin and sea buckthorn puree. These samples were treated with sodium lactate and further enriched with ascorbic acid. Sodium lactate is selected because it is derived from the processing of vegetable raw materials that naturally contain sugars. Additionally, sodium lactate of natural origin is found in the human body and is produced in the intestines during the processing of lactic acid (<https://pcgroup.ru>).

Experimental samples were prepared using local Berkanush, Big-Max, and Saporik pumpkin varieties, with sea buckthorn puree serving as an additional source of ascorbic acid.

*The objectives of the study were as follows:*

Develop a novel recipe, technology, and thermal parameters for marmalade using local pumpkin and sea buckthorn purees.

Eliminate the use of potassium sorbate (E202), replacing it with a vegetable additive, sodium lactate, which functions as a moisturizing agent, a natural preservative, and, to a lesser extent, a gelling agent.

Exclude the use of various coloring agents.

*To accomplish the final research goals, the following tasks were outlined:*

1. Investigate the chemical composition of local pumpkin varieties, including the comparative analysis of pectin substances present in them.
2. Substitute synthetic ascorbic acid with a natural food product, specifically sea buckthorn puree.
3. Evaluate the qualitative characteristics of the final samples, considering sensory and physicochemical indicators.
4. Determine optimal raw material quantities, create a new recipe, and develop the sequence of technological processes for marmalade production.

Qualitative characteristics of the final product adhered to research methods stipulated by sugar confectionery standards. The technological process followed the instructions outlined for sugar confectionery production.

The research was conducted at the “Plant Origin Products and Raw Materials Processing Technology” division of the Scientific Research Institute of Food Science and Biotechnology at the Armenian National Agrarian University.

## Results and discussions

The research team sought to create an innovative marmalade by leveraging locally abundant and cost-effective raw materials. The primary focus was on preserving the heat-resistant vitamins present in these materials throughout the entire technological process. Pumpkin was chosen as a primary raw material due to its rich content of vitamins, minerals, assimilable membrane material, and other valuable substances. Its abundant chemical composition is complemented by its beneficial dietary properties.

An effort was made to procure marmalade samples by utilizing both singular pumpkin purees and a combination of sea buckthorn purees. Formulas were meticulously selected to yield optimal sensory attributes. Recognizing the potential functional value of marmalade from these raw materials, the study considered ingredient proportions and production technological modes.

**Table 1.** Chemical composition of the local pumpkin varieties\*

Varieties	Names of indicators (%)				Vitamins (mg, %)	
	Total dry matter	Soluble dry matter	Pectinic matter	Dietary fiber	Total carotenoids	Vitamin C
Berkanush	7.7	6.8	0.6	1.2	4.5	6.7
Big-Max	4.7	4.31	0.8	1.5	2.2	5.6
Saporik	7.2	6.5	0.7	1.5	3.1	6.2

\*Composed by the authors.

Experimental marmalade samples were prepared in two variations: one exclusively from pumpkin puree and another from a blend of pumpkin and sea buckthorn purees.

To obtain test samples of marmalade, the local Berkanush, Big-Max, and Saporik pumpkin varieties were examined, and their chemical composition is detailed in Table 1.

The study highlights that the Big-Max variety of pumpkin contains the highest concentrations of pectin substances and membrane material. Nevertheless, when conducting sensory assessments of experimental marmalade samples from each variety, the Berkanush variety emerged with the most favorable taste characteristics, along with its richness in carotenoids and vitamin C.

Sea buckthorn berries are identified as a concentrated source of natural biologically active substances. These berries encompass 10-19 % dry matter, with 7.3-11.3 % being soluble. The sugar content in sea buckthorn berries ranges from 2.5-3.6 %, including sucrose, glucose, and fructose. Pectin content in these berries varies between 0.3-1.2 %. On average, 100g of sea buckthorn berries provides up to 10 daily doses of vitamin C (approximately 1.05 mg), a substantial amount of vitamin E (7-18 mg), P (up to 1 mg), as well as vitamin B1 (0.35 mg), B2 (0.3), B6 (0.79), PP, and K (0.8-1.5 mg) (Morozova, 2011, <https://health-diet.ru>).

Marmalade was crafted using a base of mashed pumpkin. The agar was pre-soaked in a specialized bath with cold water to facilitate swelling. The extent of agar's swelling is contingent upon the specific type of agar used. Preliminary calculations suggest an approximate agar-to-water ratio of 1:4. Pre-sifted sugar was added to a cooking pot, and water was incorporated at a ratio of 1:4. Subsequently, agar, molasses, and the remaining specified raw materials in the recipe were introduced gradually. The mixture was cooked until it achieved a moisture content of 27-30 %. Finally, the cooked mass was strained with the assistance of gauze, ensuring a refined texture. The syrup, upon reaching a

temperature between 71-73 °C, was cooled, and pumpkin puree was seamlessly incorporated into the mixture.

To obtain the pumpkin puree, the pumpkin was meticulously peeled, cut into pieces, steamed, and then skillfully mashed to achieve a smooth consistency. Simultaneously, a buckthorn puree was prepared. The relative proportions of pumpkin and sea buckthorn purees were deliberately selected, offering variations of 20:80, 50:50, and 80:20. After careful consideration, the 50:50 ratio was chosen from the samples prepared in three portions, as it exhibited the most optimal qualitative indicators. Additionally, a marmalade sample was prepared without the inclusion of sea buckthorn puree.

Recognizing sea buckthorn's high ascorbic acid content, the inclusion of sea buckthorn puree was carefully considered when formulating the invert sugar solution. This involved calculating the necessary amount of citric acid, taking into account that the total acids in the mixture would amount to 1 %, and the pH would fall within the range of 3.2 to 3.4.

The two purees were premixed to ensure a uniform distribution of the mass. The mixture was brought to a boil for approximately 5 minutes and then concentrated under vacuum to achieve a dry matter content of 70-74 %. When molding the final mass, the temperature was maintained at 69-70 °C. The moisture content of the mass during molding was regulated to be between 28-30 %. The gelatinization process lasted for a duration of 15-20 minutes.

To eliminate excess moisture from the marmalade and induce the formation of a crystalline crust on the outer layer, the marmalades underwent a drying process. In laboratory conditions, drying was carried out using a specialized convective dryer at temperatures ranging from 50 to 55 °C for a duration of 20 minutes. Subsequent to the drying phase, the marmalades were cooled to temperatures between 20 and 25 °C, achieving a moisture level of 18-21.5 %. They were then carefully removed from the silicone molds.

The technological scheme of the product preparation unfolds as follows:

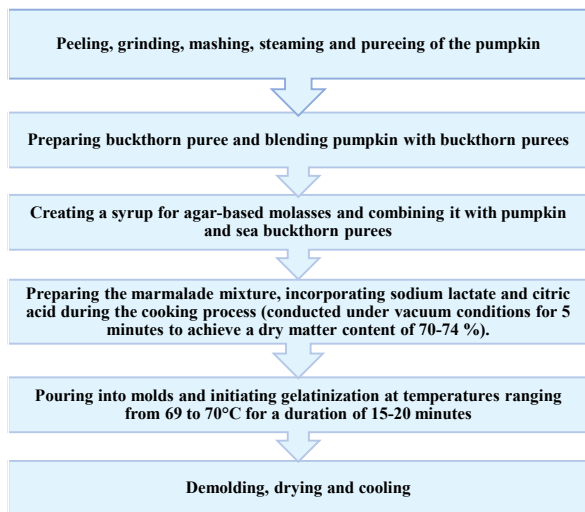

**Figure.** Technological scheme of marmalade with pumpkin and sea buckthorn puree (composed by the authors).

Given that the taste characteristics of pumpkin vary from other fruits typically employed in marmalade production, it was crucial to initially assess the sensory indicators of the new variant. This evaluation is presented in Table 2.

The physicochemical indicators of marmalade play a crucial role in determining its quality. The standards for moisture, acidity, and reducing sugars are established by regulatory guidelines. Failure to meet these standards can have a considerable impact on the safety, shelf life, and overall quality of the product.

The research results on physicochemical indicators yielded the values, presented in Table 3.

**Table 3.** Physicochemical indicators of the control sample and new types of marmalades\*

Name of indicator	Characteristics		
	Control sample	Pumpkin puree product	A product created by combining pumpkin and sea buckthorn purees
Moisture content, % (Maximum)	21.5	20.0	18.0
Soluble sugars content, % (Maximum)	25.0	25.8	26.0
Acidity, pH	8.1	8.4	5.2
Insoluble ash in 10% HCl solution, % (Maximum)	0.05	0.05	0.05

\*Composed by the authors.

**Table 2.** Sensory indicators of the control sample and new types of marmalades\*

Name of indicator	Characteristic		
	Control sample	Pumpkin puree product	A product created by combining pumpkin and sea buckthorn purees
Taste, smell, color	Characteristic of the product with this name, without additional flavors and odors	The product exhibits a more distinct pumpkin flavor, free from extraneous tastes and odors. It has a bright yellow color with the presence of pumpkin particles	Blended with distinct pumpkin and slightly acidic flavors, without off-flavors and odors. The color is yellowish-carmine, with the presence of pumpkin particles
Composition	Jelly-like	Solid jelly-like	Solid jelly-like
Form	In the form of a mold used for the given product. It maintains stability and shows no signs of damage	In the form of a mold used for the given product. It maintains stability and shows no signs of damage	In the form of a mold used for the given product. It maintains stability and shows no signs of damage
Surface	Smooth and shiny	Smooth and non-expressive shine	Smooth and shiny
Taste Score 20 points	19.1	17./6	18.9

\*Composed by the authors.

From the analysis of physicochemical indicators, it is evident that the two experimental samples of marmalade not only met the standards, but also exhibited superior physicochemical characteristics.

Based on laboratory research and calculations, the production composition of the new product was formulated for a one-year period according to finished products (Table 4). Component calculations were performed using established technological calculation methods (Skobelskaya, 2021; Pavlova, 2002).

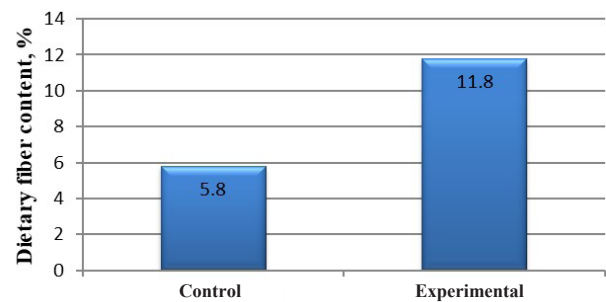

**Diagram.** The Dietary fiber content in the new marmalade product (composed by the authors).

**Table 4.** Composition of marmalade made with pumpkin and buckthorn puree\*

Name of indicator	Amount of dry matter, %	Based on the yearly calculation of the final product in kilograms	
		By weight	By dry matter
Sugar	99.85	580.2	579.1
Molasses	78.0	260.0	202.8
Agar	85.0	9.0	76.5
Pumpkin puree + sea buckthorn puree (50:50 ratio)	10.0	152.0	12.0
Citric acid	99.0	9.0	0.8
Sodium lactate	50.0	10.0	5.0
Total	-	1020.2	876.2
Yield	82	1000.0	820.0

\*Composed by the authors.

One of the objectives in developing new marmalade products is to enhance dietary fiber content using alternative raw materials. The human body typically requires 25-30 g of dietary fibers per day (Chernikov, 2019). Pumpkin contains 1.5 % of dietary fiber in 100 g, while sea buckthorn can have up to 10 % in the same quantity. The nutritional value of 100 g marmalade includes 6 % dietary fiber. Theoretically, it can be inferred that the new product should have an increased content of dietary fibers since they are not significantly degraded during reheating. To experimentally determine the dietary fiber content in marmalade, a corresponding experiment was conducted, and the results are presented in Diagram. As shown in Diagram, the dietary fiber content in the control sample was 5.8 %, while in the samples prepared with a mixture of pumpkin and sea buckthorn puree, it reached 11.8 %. In other words, the food fiber content in the new product has doubled, providing the product with added functional significance. The data of the research result related to microbiological indicators are presented in Table 5.

**Table 5.** Microbiological indicators of the control sample and new types of marmalades\*

Names of indicators	Characteristics				
	Mesophilic aerobic and facultative anaerobic microorganisms (CFU/g), no more	Intestinal coliform bacteria (coli forms) are not allowed in the food mass (g/cm <sup>3</sup> )	Pathogen, including Salmonella, weight of food (g), in which it is not allowed: 25 g	Molds (CFU/g), no more	Yeasts, (CFU/g), no more
Permissible levels	1x10 <sup>3</sup>	1.0	Not allowed	100	50
Control sample	1x10 <sup>3</sup>	1.0	Not detected	Not detected	Not detected
A Product made with pumpkin puree	1x10 <sup>3</sup>	Not detected	Not detected	Not detected	Not detected
A product made with a blend of pumpkin and sea buckthorn purees	1x10 <sup>3</sup>	Not detected	Not detected	Not detected	Not detected

\*Composed by the authors.

After examination of microbiological indicators, it has been established that the obtained samples comply with the requirements set forth in the Technical Regulation of the Customs Union on Food Safety (“TR TS”) 021/2011.

### Conclusion

Based on the research findings, it is evident that local varieties of pumpkin and sea buckthorn can serve as novel raw materials in sugar confectionery.

#### *Additionally:*

A potential method and the optimal way to utilize pumpkin and sea buckthorn have been established.

The content of dietary fiber in the finished product was assessed.

The study demonstrated the feasibility of excluding colorants and other additives in products crafted from the selected raw materials.

The study revealed an increase in the nutritional fiber content of the product manufactured using the developed technology and portions.

The utilization of pumpkin and sea buckthorn purees in the production of sugar confectionery, as cost-effective and locally sourced ingredients, proves highly effective and facilitates the expanded utilization of local raw materials.

### References

- Chernikov, A. (2019). Fiber 5th element of a healthy diet//Tomsk, - 84 p. (in Russian).
- Council directive 2001/113/EC of 20 December 2001 relating to fruit jams, jellies and marmalades and sweetened chestnut purée intended for human consumption. Official Journal of the European Communities.
- Emelike, N.J.T., Akusu, O.M. (2019). Quality Attributes of Jams and Marmalades Produced from Some Selected Tropical Fruits // Journal of Food Processing & Technology. - V. 10 (5). doi: 10.4172/2157-7110.1000790.
- Kalidas Shetty, Dipayan Sarkar (2020). Functional Foods and Biotechnology Biotransformation and Analysis of Functional Foods and Ingredients/1st Edition. Pub. Location Boca Raton, - pp. 5-9 <http://dx.doi.org/10.1201/9781003003793>.
- Magomedov, G.O., Lobosova, L.A., Zhurahova, S.N. (2017). Jelly - fruit marmalade of increased food value with juice from sea buckthorn berries // Technology and technology of food production - № 3, - pp. 50–54 (in Russian).
- Morozova, E.I. (2011). Medicinal properties of buckthorn, sea buckthorn, rose hip. - Donetsk. OOO “PKF” “BAO”, -240 p. (in Russian).
- Navnidhi Chhikara, Anil Panghal and Gaurav Chaudhary (2022). Functional Foods/Scrivener Publishing (LLC), - 2-6 p. <http://dx.doi.org/10.1002/9781119776345>.
- Pavlova, N.S. (2000). Collection of basic recipes of sugar confectionery products - SPb. GIORD, - pp.160-176.
- Skobelskaya, Z.G. (2021). Technology of confectionery products. Calculation recipe. Textbook / izd., ster.- Saint-Petersburg, - 84 p. (in Russian).
- Tefikova, S.N., Nikitin, I.A., Kondratyev, N.B., Semenkina, N.G. (2018). Expansion of the assortment of jelly-shaped marmalade based on vegetable puree // Vestnik of the Voronezh State University of Engineering Technologies. V. 80. № 2, - pp. 165–174 (in Russian) <http://dx.doi.org/10.20914/2310-1202-2018-2-165-174>.
- Zubchenko, A.V. (1999). Technology of confectionery production. Voronezh, - 432 p.
- [https://health-diet.ru/base\\_of\\_food/sostav/240.php](https://health-diet.ru/base_of_food/sostav/240.php) (accessed on 10.06.2023).
- [https://yandex.ru/patents/doc/RU2630236C1\\_20170906](https://yandex.ru/patents/doc/RU2630236C1_20170906) (accessed on 14.06.2023).
- <http://agroecoarm.com/wpcontent/uploads/2016/07/%D5%89%D4%BB%D5%89%D4%BD%D4%B1%D5%86-Sea-buckthorn-Hippophae.pdf> (accessed on 21.05.2023).
- <https://calorizator.ru/product/vegetable/pumpkin-1> (accessed on 22.05.2023).
- <https://pcgroup.ru/blog/laktat-natriya-vazhnejshij-dlya-pisheproma-i-kosmeticheskoy-industrii-reaktiv/> (accessed on 19.09.2023).

*Accepted on 26.09.2023*

*Reviewed on 01.12.2023*





UDC 663.241

## Studying the Effects of Various Yeast on the Three-Year Aging Process of Brandy Spirits Made From “Kangun” and “Meghrabuyr” Grape Varieties

T.L. Khachatryan, L.V. Shahinyan, Sh.H. Harutyunyan, A.H. Nersisyan

Yerevan Ararat Brandy-Wine-Vodka Factory

[khachatryantigrannoy@mail.ru](mailto:khachatryantigrannoy@mail.ru), [winelus@mail.ru](mailto:winelus@mail.ru), [shushanh@mail.ru](mailto:shushanh@mail.ru), [albertnersisyan@mail.ru](mailto:albertnersisyan@mail.ru)

### ARTICLE INFO

**Keywords:**

*aging,  
Brandy spirit,  
oak barrel,  
sensory perception,  
volatile aromatics*

### ABSTRACT

Brandy spirits, matured for three years and produced with various yeasts, were examined to assess their quality. The study included evaluating sensory indicators and conducting a qualitative and quantitative analysis of volatile aromatic compounds. Results showed that brandy spirits fermented with “Oenoferm Bouquet” yeast, displayed the highest concentrations of volatile aromatic substances, with this variant receiving the most favorable tasting evaluation among the sampled spirits.

### Introduction

It is well-established that yeasts play a significant role in brandy production. The use of different yeasts alters the qualitative composition of brandy wine materials, the revelation of this fact also became apparent during our research. Taking into account the obtained results, we delved into the study of brandy spirits from the scrutinized brandy wine materials distilled and further aged for three years in oak barrels (Petrosyan, et al., 1991).

Volatile aromatic substances play a crucial role in shaping the sensory characteristics of aged brandy spirits, and our study is dedicated to the qualitative and quantitative exploration of these compounds. The latter transforms into young brandy, drawing from both the brandy wine materials and the distillation process they undergo.

The quality of the wine spirit from which brandy is produced depends on many factors during the production process; however, we can distinguish the following: primary aroma substances which are generated from the grape varieties; secondary aroma substances generated during the vinification and fermentation process following the aroma substances generated during the distillation and maturation process (Milicevic, et al., 2002). The main aroma compounds of grapes belong to the chemical classes of terpenols, linalool, geraniol, and nerol, norisoprenoids,  $\beta$ -damascone,  $\beta$ -damascenone; benzenoids,  $\beta$ -phenylethanol, methyl salicylate, etc. Volatiles originating from the fermentation process are mainly constituted by alcohols, 2-methyl-1-propanol,  $\beta$ -phenylethanol, isoamyl alcohols formed by the Ehrlich pathway, and fruity esters, such as ethyl esters and acetates,

ethyl hexanoate, octanoate, and decanoate, isoamyl acetates (Flamini, 2009). Moreover, other volatiles such as acetals, ethoxy derivatives, and other terpenols such as  $\alpha$ -terpineol, and terpinen-4-ol are formed by the hydrolytic reactions which occur during distillation and that are promoted by the high ethanol content and temperature (Mayr, et al., 2021).

The olfactory characteristics of aged brandy spirit are attributed to aromatic substances derived from natural oak wood, emerging through their transformation and aging. This includes middle esters, volatile acids, higher alcohols, aldehydes, and more (Skurikhin, 2005).

Our investigation explored the sensory characteristics of brandy spirits derived from diverse grape varieties and yeasts. Additionally, we conducted a qualitative-quantitative analysis of volatile aromatic substances using gas chromatography. The studied brandy spirits underwent a three-year aging process in Artsakh oak barrels (80 cm<sup>2</sup> per liter), with a regular enrichment of oxygen during the aging period (Kazumyan, et al., 2012).

## Materials and methods

The research material comprised brandy spirits obtained from distillation of the brandy wine materials made of individual “Kangun” and “Meghrabuyr” grape varieties and three-year aging in oak barrels. These spirits were fermented using “FC” 9 yeast from the Danish company “Lalvin” along with “Oenoferm C 2” and “Oenoferm Bouquet” *Saccharomyces cerevisiae* strains. A control sample consisted of brandy spirits distilled from wine materials obtained through spontaneous fermentation from the same grape varieties and subjected to a 3-year aging process.

The assessment of taste is contingent upon the examination of individual constituents, including ethyl spirit, sugar colors, high molecular spirits, ethers, aldehydes, acids, vanillin, lignin, furfural, ethyl acetate, acetaldehyde, acetic acid, and mineral substances. The collective interplay of these components, termed harmony, holds considerable sway in shaping the overall taste perception. Additionally, the sustained taste experience lingering in the mouth further contributes to the holistic evaluation of flavor (Avanesyants, et al., 2010).

The research activities took place within the laboratory and tasting hall of the Scientific Research Center at Yerevan Ararat Brandy Wine Vodka Combine JSC. The tasting committee, consisting of 11 individuals, undertook

the evaluation of brandy spirit quality utilizing both 8- and 10-point assessment systems, conforming to the standards accepted in the Commonwealth of Independent States (CIS) countries. Qualitative and quantitative analyses of the volatile aromatic compounds in the researched samples were executed using an “Agilent 7890” gas chromatograph manufactured in the USA. This equipment features a quartz capillary tower, incorporating two ionizing detectors — flame ionization (FID) and mass spectral detectors — operating in parallel. The analysis duration was set at 45 minutes. The equipment is specifically equipped with an HP-FFAP capillary tower, boasting an inner diameter of 0.25 mm and a length of 30 m. Dual detection was achieved by connecting a flame ionization detector (FID) and an “Agilent 5975C” mass spectrometer in parallel.

The gas chromatograph operates under the following parameters:

- Carrier gas: Helium of 99.999 % purity
- Combustible gases: Hydrogen and air
- Sample injection volume: 0.8  $\mu$ l
- Gas flow rate: 0.3 ml/min
- Constant injector temperature: 290 °C
- Gas flow split ratio: 1:50
- Thermostat temperature range: 35°C to 230 °C
- Flame ionization detector temperature: 250 °C
- Analysis duration: 42.4 minutes

Calibration involved the construction of a scaling curve using German standard solutions. Post-experimentation, a thorough analysis of the obtained results is conducted.

## Results and discussions

Figure, illustrates the averaged evaluations of sensory indicators for brandy spirits made from “Kangun” and “Meghrabuyr” grape varieties, aged over 3 years. A discernment of the sensory indicators depicted in the chart reveals that the highest score, 9.1 points, was attributed to the brandy spirit fermented with “Oenoferm Bouquet” yeast. This specific variant was derived from “Kangun” grapes and underwent a 3-year aging process. In contrast, the lowest score was assigned to the spontaneously fermented brandy.

The same trend is evident in the case of the “Meghrabuyr” variety, affirming that brandy spirits produced with “Oenoferm Bouquet” yeasts achieved the highest sensory assessment.

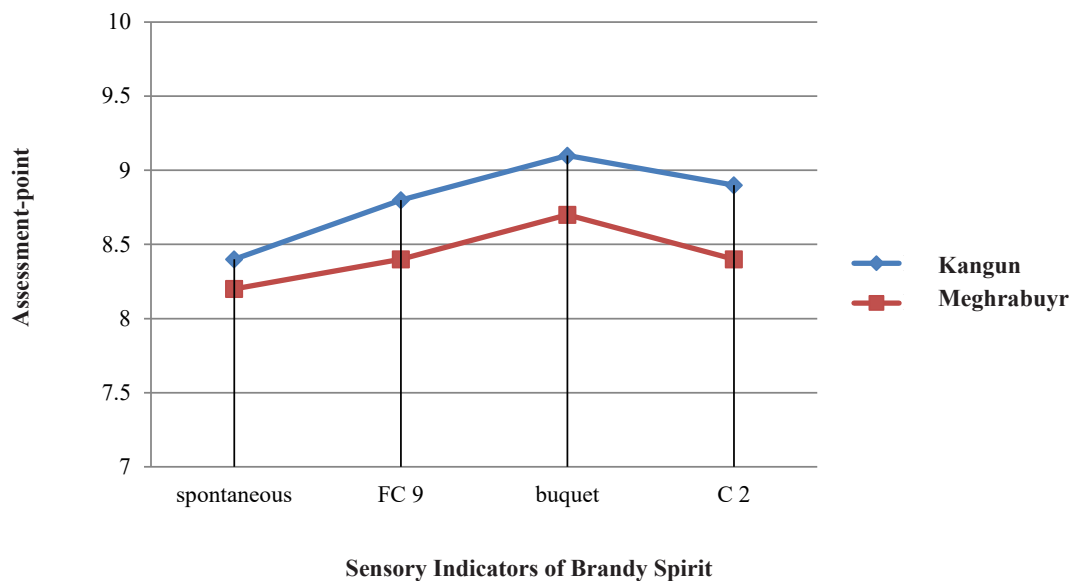

**Figure.** Sensory Indicators of Brandy Spirits Depending on Yeast Strains and Grape Varieties (*composed by the authors*).

A parallel observation emerges when scrutinizing the results of gas chromatographic analysis of volatile aromatic substances (Table).

Gas chromatography identified 24 volatile aromatic compounds in the analyzed samples.

The table reveals variations in the concentrations of high alcohols - specifically, 3-methylbutanol-1, 2-methylpropanol-1, and propanol-1, furthermore, the overall quantity of these compounds is notably elevated in brandy spirits derived from “Oenoferm C2” yeasts. Of significance is the peak concentration of propanol-1 in the “Oenoferm Bouquet” brandy spirits samples, contributing a fruity nuance, 23.5 mg/100 ml EtOH in the case of “Kangun” variety and 21.3 mg/100 ml EtOH in the case of “Meghrabuyr” ones.

During the aging of brandy spirits, tannins assume a crucial role in the generation of aldehydes, serving simultaneously as antioxidants that deter oxidation. The regeneration of aldehydes is further facilitated by semi-membranes, their partial hydrolysis yielding various monomeric compounds such as sugars (hexoses, pentoses, etc.). Within the aging process of brandy spirits, specific transformations involving pentoses, methyl pentoses, and hexoses lead to the production of aldehydes belonging to the furan series - namely, furfural, methylfurfural, and oxymethylfurfural. These aldehydes significantly contribute to the development of the taste and aroma profiles of brandy. Additional

sources of aldehydes encompass the intricate processes of oxidation-reduction and melanoidin formation involving amino acids (Sarishvili, et al., 1998).

Acetaldehyde emerges as the predominant aldehyde in the examined samples, reaching its highest concentration in spontaneously fermented brandy spirit samples at 8.23 mg/100 ml EtOH. Notably, in brandy wine spirits distilled and aged from “Kangun” grapes, this content was recorded at 7.9 mg/100 ml EtOH and for “Meghrabuyr”, at 7.9 mg/100 ml EtOH. “Oenoferm Bouquet” brandy spirits exhibited elevated levels of furfural and methylfurfural. Specifically, in the “Kangun” sample, concentrations were 1.9 mg/L for furfural and 0.2 mg/L for methylfurfural, while for “Meghrabuyr”, the levels were 1.6 mg/L and 0.15 mg/L, respectively. Esters, essential components of volatile aromatic substances, play an irreplaceable role and are generated during processes such as ester formation, melanoidin formation, decomposition, and oxidation-reduction conversions. Acetic acid ethyl ester dominates in all samples, renowned for its pungent aroma. The highest concentration is observed in samples obtained through spontaneous fermentation. Notably, other esters - propionic acid methyl, hexanoic acid ethyl, octanoic acid ethyl, dodecanoic acid ethyl, and tetradecanoic acid ethyl esters - are abundant in “Oenoferm Bouquet” brandy spirits, both in “Meghrabuyr” and “Kangun” samples (Harutyunyan, et al., 2018).

**Table.** Qualitative and Quantitative Composition of Volatile Aromatic Substances in Brandy Spirits from “Kangun” and “Meghrabuyr” Grape Varieties\*

N	Volatile substances, mg/100 ml of anhydrous spirit	Kangun				Meghrabuyr			
		Sp.	Bouquet	FC 9	C 2	Sp.	Bouquet	FC 9	C 2
3	Butanol-2	0.08	0.03	0.062	0.017	0.09	0.09	0.054	0.05
4	Butanol-1	0.95	0.85	0.66	1.4	1.22	0.96	0.78	1.43
5	Propanol-1	19.8	23.5	21.0	20.3	20.9	21.3	17.8	15.9
6	2-methylpropanol-1	66.9	85.2	84.8	82.5	74.6	83.9	82.3	79.6
7	Isoamyl spirit	290.6	342.6	299.0	360.5	302.3	359.6	326.6	368.6
8	Hexanol-1	3.56	3.52	3.63	3.95	4.55	3.56	4.52	4.89
9	Octanol-1	0.04	0.036	0.04	1.16	0.068	1.2	0.045	1.26
10	Phenyl ethanol-1	65.9	98.6	42.6	100.5	60.8	89.6	66.6	100.6
11	Acetic acid methyl ester	0.58	0.65	0.39	0.5	0.56	0.69	0.45	0.52
12	Acetic acid ethyl ester	44.5	45.7	40.5	45.2	40.9	45.9	41.9	42.3
13	Propionic acid methyl ester	ND	ND	ND	ND	ND	ND	ND	ND
14	3-methylbutanol-1	0.9	1.89	1.0	1.3	1.2	2.2	1.6	1.7
15	Hexanoic acid ethyl ester	0.18	0.19	0.16	0.16	0.25	0.38	0.37	0.345
16	Ethyl lactate	25.6	18.9	23.6	20.9	45.6	36.5	34.5	25.9
17	Ethyl ester of octanoic acid	0.6	0.49	0.33	0.35	0.36	0.69	0.98	0.99
18	Dodecanoic acid ethyl ester	0.48	0.68	0.64	0.42	0.36	0.56	0.46	0.23
19	Tetradecanoic acid ethyl ester	0.45	0.69	0.59	0.26	0.22	0.36	0.12	0.21
20	Acetaldehyde	8.23	7.65	6.36	6.8	7.88	6.9	5.25	5.40
21	1,1-diethoxyethane	1.3	ND	ND	ND	ND	ND	ND	ND
22	Furfural, mg/l	1.1	1.9	1.4	1.5	0.9	1.6	1.4	1.3
23	MethylFurfural, mg/l	0.11	0.2	0.1	0.1	0.09	0.15	0.08	0.08
24	Methanol, mg/l	0.56	0.69	0.8	0.78	0.9	0.89	0.78	0.9

\*Composed by the authors.

## Conclusion

Our study delved into the sensory indicators of brandy spirits, distilled from wine materials sourced from “Kangun” and “Meghrabuyr” grape varieties, and aged for three years. The qualitative-quantitative composition of volatile aromatic substances was meticulously examined through gas chromatography. The fermentation options considered for the research involved “FC 9” from the Danish “Lalvin” company, “Oenoferm C 2” and *Saccharomyces cerevisiae* yeasts from the German “Erbslöh” company. The data obtained reveals that the

brandy spirits fermented with “Oenoferm Bouquet” yeasts exhibited the highest concentrations of volatile aromatic substances, a finding consistently affirmed through sensory evaluations during tasting sessions.

## References

1. Avanesyants, R.V., Ageev, N.M., Minasov, E.R., Avanesyants, R.A. (2010). “Intensification of the ripening process of brandy spirit” // “Winemaking and viticulture”, №. 3, - pp. 10 -11 (in Russian).

2. Flamini, R. (2009). *Mass Spectrometry in Grape and Wine Chemistry* Wiley-Interscience Series in Mass Spectrometry; Wiley-Blackwell: Hoboken, NJ, USA, ISBN 9780470392478 <http://dx.doi.org/10.1002/9780470552926.scard>.
3. Harutyunyan, M.Zh. (2015). The function of yeast sediment in the process of wine material distillation for brandy // Newsletter of the National Agrarian University of Armenia. a. - № 1. – pp. 98-102.
4. Harutyunyan, M.Zh., Xachatryan, T. L., Shaginyan, L. V. (2018). The influence of yeasts on the quality of volatile aromatic substances of brandy wine materials made from Kangun and Meghrabuyr sorts of grapes.
5. Kazumyan, K.N., Guguchkina, T.I., Oseledtseva, I.V., Sukoyan, M.R. (2012). Study of aromatic components of cognac spirits aged from 3 to 30 years // Newsletter of the National Agrarian University of Armenia, Yerevan, 2012, N3, - pp. 80-83.
6. Mayr, M.C., De Rosso, M., Carraro, R., Flamini, R. (2021). Changes in volatile compounds of grape pomace distillate (Italian grappa) during one-year aging in oak and cherry barrels. *Food Chem.*, 344, 128658 <http://dx.doi.org/10.1016/j.foodchem.2020.128658>.
7. Milicevic, B., Banovic, M., Kovacevic-Ganic, K., Gracin, L. (2002). Impact of grape varieties on wine distillates flavor. *Food Technol. Biotechnol.* 40, - pp. 227–232.
8. Petrosyan, T.L., Voskanyan, A.V. (1991). Volatile phenols of young brandy spirits // *Viticulture and winemaking*. – Yalta, - № 5, - pp. 48-51 (in Russian).
9. Sarishvili, N.G., Oganesyants, L.A., Makulkina, O.S., Osipova, V.P., Kobelev, K.V. (1998). Method for obtaining crystalline oak extract, Author's certificate, №. 2114171 (in Russian).
10. Skurikhin, I.M. (2005). *Chemistry of cognac and brandy*. - Moscow. ed. DeLiPrint, - p 296 (in Russian).

---

*Accepted on 29.09.2023*

*Reviewed on 09.10.2023*



ՊԱՐԲԵՐԱԿԱՆ ԵՎ ԴՈԿՏՈՐԱԿԱՆ ԵՎ ԹԵԿՆՈԳԻԱԿԱՆ ԱՏԵՆԱԽՈՍՈՒԹՅՈՒՆՆԵՐԻ ԱՐԴՅՈՒՔՆԵՐԻ ԵՎ ԴՈՒՅԹՆԵՐԻ ԳՐԱԴԱՐԱՆԱՆ ՀԱՄԱՐ ՀՀ ԿԳՄՍ ԲՈՎԻ ԿՈՂՄԻՑ ԸՆԴՈՒՆԵԼԻ ԳԻՏԱԿԱՆ ՀԱՆՐԱՆՆԵՐԻ ՑԱՆԿՈՒՄ:

ИЗДАНИЕ ВКЛЮЧЕНО В ПЕРЕЧЕНЬ ВЕДУЩИХ НАУЧНЫХ ЖУРНАЛОВ ВАК МНОКС РА, В КОТОРЫХ ДОЛЖНЫ БЫТЬ ОПУБЛИКОВАНЫ ОСНОВНЫЕ РЕЗУЛЬТАТЫ И ПОЛОЖЕНИЯ ДИССЕРТАЦИЙ НА СОИСКАНИЕ УЧЕНОЙ СТЕПЕНИ ДОКТОРА И КАНДИДАТА НАУК.

THE JOURNAL IS INVOLVED IN THE LIST OF SCIENTIFIC PERIODICALS RELEVANT FOR PUBLICATIONS OF THE RESULTS AND PROVISIONS OF DOCTORAL AND PHD THESES AND APPROVED BY THE HIGHER EDUCATION QUALIFICATION COMMITTEE OF THE RA MoESCS.

### ՀՈՂՎԱԾՆԵՐԻ ԸՆԴՈՒՆՄԱՆ ԿԱՐԳԸ

1. Հոդվածներն ընդունվում են հայերեն, ռուսերեն և անգլերեն լեզուներով:
  2. Հոդվածի առավելագույն ծավալը չպետք է գերազանցի 10 համակարգչային էջը (ներառյալ ամփոփագրերը):
  3. Հեղինակների թիվը չպետք է գերազանցի չորսը:
  4. Հեղինակների տվյալներում պետք է ներառվեն հեղինակ(ներ)ի անունը, ազգանունը, հայրանունը, գիտական աստիճանը, աշխատավայրը, էլ. հասցեն:
  5. Հոդվածը ներկայացվում է տպագիր և էլեկտրոնային (WORD ձևաչափով) տարբերակներով:
  6. **Հոդվածը շարադրվում է հետևյալ կառուցվածքով.** վերնագիր, 5 բանալի բառ, «Նախաբան», «Նյութը և մեթոդները», «Արդյունքները և վերլուծությունը», «Եզրակացություն», «Գրականություն»:
  7. Գրականության հղումները կատարվում են տեքստում՝ փակագծում նշվում են հեղինակը և հրատարակման տարբերակը:
  8. Հոդվածները պետք է ունենան ամփոփագրեր. հայերենով և ռուսերենով ներկայացված հոդվածների դեպքում՝ հայերեն (առնվազն 60 բառ), ռուսերեն (առնվազն 60 բառ) և անգլերեն (150-250 բառ), անգլերենի դեպքում՝ անգլերեն լեզվով (առնվազն 60 բառ):
  9. Հայերեն և ռուսերեն հոդվածների վերնագրերը, հեղինակ(ներ)ի տվյալները և բանալի բառերը ներկայացվում են հայերեն, ռուսերեն և անգլերեն լեզուներով:
  10. Գրականության ցանկը ներկայացվում է առնվազն 10 անուն, շարադրվում է այբբենական կարգով:
  11. Մեքսերված գրականության աղբյուրների առնվազն 30%-ը պետք է հրատարակված լինի վերջին տասը տարիներին:
  12. Էլեկտրոնային հղումը որպես աղբյուր մեքսերված գրականության ցանկում նշվում է դիտման ամսաթիվը:
- Հոդվածներին ներկայացվող տեխնիկական պահանջներն են.** անգլերեն և ռուսերեն հոդվածների տառատեսակը՝ Times New Roman, հայերեն հոդվածներին՝ GHEA Grapalat, տառաչափը՝ 12, միջտողային տարածությունը՝ 1.5, վերնագիրը՝ մեծատառերով, գծապատկերները՝ Word, Excel ծրագրերով, աղյուսակները՝ ուղղահայաց դիրքով (Portrait), բանաձևերը՝ Microsoft Equation 3.0 ձևաչափով:

**Կարգին չհամապատասխանող հոդվածները չեն ընդունվում:** Հոդվածներն ուղարկվում են գրախոսման: Մերժված հոդվածները չեն վերադարձվում հեղինակին: Հոդվածները չեն հրատարակվի, եթե ամբողջությամբ կամ համառոտ տպագրված լինեն այլ պարբերականում:

### ПОРЯДОК ПРИЁМА СТАТЕЙ

1. Статьи принимаются на армянском, русском и английском языках.
  2. Объем статьи не должен превышать 10 компьютерных страниц (включая аннотации).
  3. Число авторов не должно превышать четырёх.
  4. В сведениях об авторах должны быть включены имя (имена), фамилия, отчество, научная степень, место работы, эл.адрес.
  5. Статья представляется в печатном и электронном (в формате WORD) вариантах.
  6. **Статья должна быть изложена следующим образом:** заглавие, 5 ключевых слов, "Введение", "Материал и методы", "Результаты и анализ", "Заключение", "Литература".
  7. Библиографические ссылки указываются в тексте (в скобках пишутся фамилия автора и год издания).
  8. Статьи должны иметь аннотации: статьи, представленные на армянском и русском языках – на армянском (не менее 60 слов), на русском (не менее 60 слов) и на английском (150-250 слов). В случае статей, написанных на английском, аннотация должна быть на английском языке (не менее 60 слов).
  9. Заглавия, данные автора (авторов) и ключевые слова статей на армянском и русском языках представляются на армянском, русском и английском языках.
  10. Список литературы должен содержать не менее 10 наименований источников, указанных в алфавитном порядке.
  11. Не менее 30% цитируемых литературных источников должны быть опубликованы в течение последних десяти лет.
  12. При ссылке на интернет-ресурс как на источник информации в библиографическом списке необходимо указать дату просмотра.
- Технические требования к статьям:** для статей на английском и русском языках – шрифт Times New Roman, для армянского – GHEA Grapalat; размер букв – 12; межстрочное расстояние – 1.5; заголовок – прописными буквами; графические изображения – программой Word, Excel; таблицы – вертикально (Portrait); формулы – в формате Microsoft Equation 3.0;

**Статьи, не отвечающие требованиям, не будут приняты. Статьи передаются на рецензирование. Статьи, не принятые к печати, не возвращаются автору. Статьи не будут опубликованы, если ранее были полностью или частично опубликованы в других периодических изданиях.**

### THE STANDARDS FOR SUBMITTING ARTICLES

1. The articles are accepted in Armenian, Russian and English languages.
2. The size of the article shouldn't exceed 10 PC pages (including summaries).
3. The number of authors should not exceed four.
4. Full name, academic degree, workplace and e-mail of the author (s) should be included in the information about the authors.
5. The article is submitted in a hard copy and electronically (WORD format).
6. **The article should have the following structure:** title, 5 keywords, "Introduction", "Materials and Methods", "Results and Discussions", "Conclusion", "References".
7. References to the literature should be indicated in the text (the author and the date of publication in the parentheses).
8. The articles should have abstracts: in case of Armenian and Russian articles, abstracts in Armenian (minimum 60 words), Russian (minimum 60 words) and English (150-250 words) languages should be submitted, while in case of English articles, abstracts in English (minimum 60 words) language should be submitted.
9. The titles, information about the author(s) and keywords should be presented in Armenian, Russian and English languages.
10. The list of literature should be presented with at least 10 names, arranged in alphabetical order.
11. At least 30% of the literature sources being cited in the article, must have been published within the last ten years.
12. When citing internet links as a literature source the date of access should be mentioned.

**Technical requirements for articles:** font for English and Russian articles: Times New Roman, for Armenian articles: GHEA Grapalat, font size: 12, interstitial spacing: 1.5, title: with capital letters, charts: with Word, Excel, tables: vertical (Portrait), formulas: in Microsoft Equation 3.0 format.

**Articles that do not meet the requirements are not accepted. Articles are sent for review. Refused articles are not returned to the authors. The articles which are already published in other scientific journals (completely or partially) can't be valid for publication in our journal.**